

Description

The YB1680 is a 1.5MHz constant frequency, slope compensated current mode PWM step-down converter. The device integrates a main switch and a synchronous rectifier for high efficiency without an external Schottky diode. It is ideal for powering portable equipment that runs from a single cell lithium-Ion (Li+) battery. The YB1680 can supply 600mA of load current from a 2.5V to 5.5V input voltage. The output voltage can be regulated as low as 0.6V. The YB1680 can also run at 100% duty cycle for low dropout operation, extending battery life in portable system. Idle mode operation at light loads provides very low output ripple voltage for noise sensitive applications.

The YB1680 is offered in a low profile 5-pin, SOT package, and is available in an adjustable version.

Features

- High Efficiency : Up to 94%
- 1.5MHz Constant Switching Frequency
- 600mA Output Current at $V_{IN}=3V$
- Integrated Main Switch and Synchronous Rectifier. No Schottky Diode Required
- 2.5V to 5.5V Input Voltage Range
- Output Voltage as Low as 0.6V
- 100% Duty Cycle in Dropout
- Low Quiescent Current : 300 μ A
- Slope Compensated Current Mode Control for Excellent Line and Load Transient Response
- Short Circuit Protection
- Thermal Fault Protection
- <1 μ A Shutdown Current
- Space Saving 5-Pin SOT23 Package
- Pb-free Package

Applications

- Cellular and Smart Phones
- Microprocessors and DSP Core Supplies
- Wireless and DSL Modems
- PDAs
- MP3 Player
- Digital Still and Video Cameras
- Portable Instruments

Typical Application Circuit

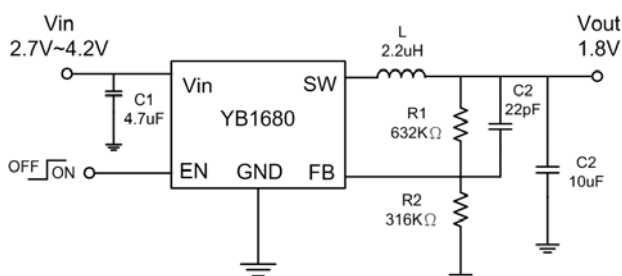
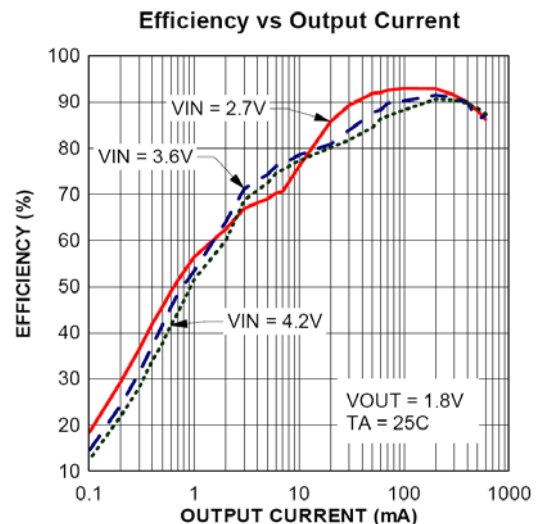

Figure 1: Typical Application Circuit



Pin Configuration

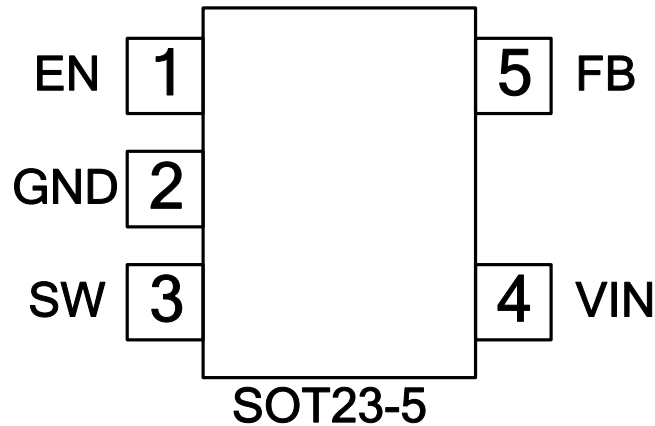

Figure 2: Pin Configuration

Pin Description

Table 1

Pin	Name	Description
1	EN	Regulator Enable control input. Drive EN above 1.5V to turn on the part. Drive EN below 0.3V to turn it off. In shutdown, all functions are disabled drawing <math><1\mu\text{A}</math> supply current. Do not leave EN floating.
2	GND	Ground.
3	SW	Power Switch Output. It is the Switch node connection to Inductor. This pin connects to the drains of the internal P-CH and N-CH MOSFET switches.
4	VIN	Supply Input Pin. Must be closely decoupled to GND, Pin 2, with a 2.2 μF or greater ceramic capacitor.
5	FB	VFB (Adjustable Version) : Feedback Input Pin. Connect FB to the center point of the external resistor divider. The feedback threshold voltage is 0.6V.

Ordering Information

Order Number	Package Type	Supplied As	Package Marking
YB1680ST25XADJP	SOT23-5	3000 units Tape & Reel	A1XY (Note 1)

Note 1: XY = Manufacturing Date Code

Absolute Maximum Ratings

Input Supply Voltage	-0.3V to 6V	Operating Temperature Range ..	-40°C to 85°C
EN, V _{FB} Voltage	-0.3V to V _{IN} +0.3V	Junction Temperature	125°C
SW, V _{OUT} Voltage	-0.3V to V _{IN} +0.3V	Storage Temperature Range ...	-65°C to 150°C
Peak SW Sink and Source Current.....	1.5A	Lead Temperature (Soldering, 10s) ..	300°C

Electrical Characteristics

Table 2 (V_{IN} = V_{RUN} = 3.6V, T_A=25°C, Test Circuit Figure 1, unless otherwise noted.)

Description	Symbol	Test Conditions	MIN	TYP	MAX	Units
Input Voltage Range	V _{IN}		2.5		5.5	V
Input DC Supply Current Active Mode Shutdown Mode	I _Q	V _{FB} = 0.5V V _{FB} = 0V, V _{IN} = 4.2V		270 0.08	400 1.0	μA
Regulated Feedback Voltage	V _{FB}	T _A = +25°C	0.5880	0.6000	0.6120	V
		T _A = 0°C ≤ T _A ≤ 85°C	0.5865	0.6000	0.6135	
		T _A = -40°C ≤ T _A ≤ 85°C	0.5850	0.6000	0.6150	
V _{FB} Input Bias Current	I _{FB}	V _{FB} = 0.65V			±30	nA
Reference Voltage Line Regulation		V _{FB} = 2.5V to 5.5V, V _{OUT} = V _{FB} (R2=0)		0.11	0.63	%/V
Output Voltage Line Regulation		V _{IN} = 2.5V to 5.5V, I _{OUT} = 10mA		0.11	0.63	%/V
Output Voltage Load Regulation		I _{OUT} from 0 to 600mA		0.0015		%/mA
Maximum Output Current		V _{IN} = 3.0V	600			mA
Oscillator Frequency	F _{OSC}	V _{FB} = 0.6V or V _{OUT} = 100%	1.2	1.5	1.8	MHz
R _{DS(ON)} of P-CH MOSFET		I _{SW} = 300mA		0.30	0.50	Ω
R _{DS(ON)} of N-CH MOSFET		I _{SW} = -300mA		0.20	0.45	Ω
Peak Inductor Current		V _{IN} = 3V, V _{FB} = 0.5V or V _{OUT} = 90% Duty Cycle < 35%		1.20		A
SW Leakage		V _{RUN} = 0V, V _{SW} = 0V or 5V, V _{IN} = 5V		±0.01	±1	μA
Output Over Voltage Lockout		ΔV _{OVL} = V _{OVL} - V _{FB}		60		mV
EN Threshold	V _{EN}	-40°C ≤ T _A ≤ 85°C	0.3	0.45	1.30	V
EN Leakage Current	I _{EN}			±0.1	±1	μA

Typical Performance Characteristics

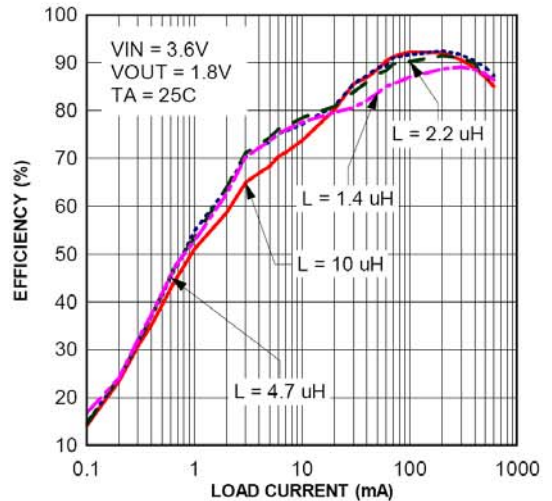
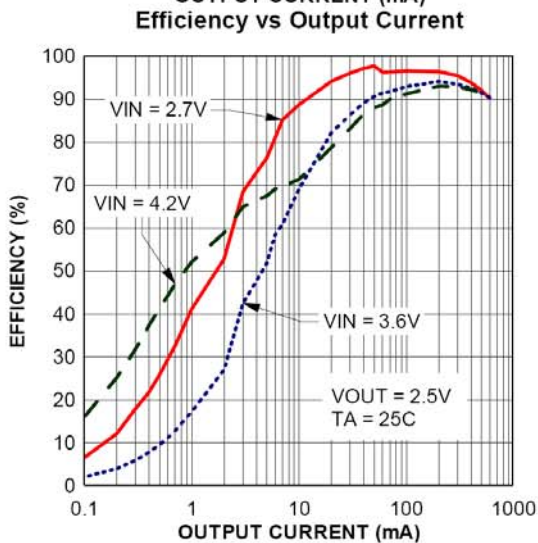
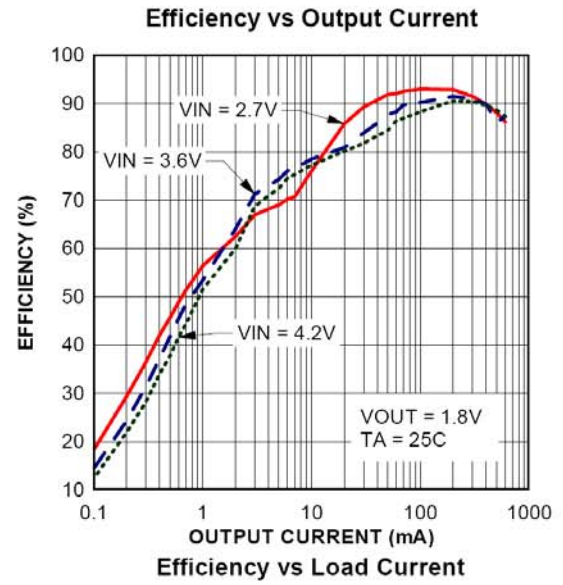
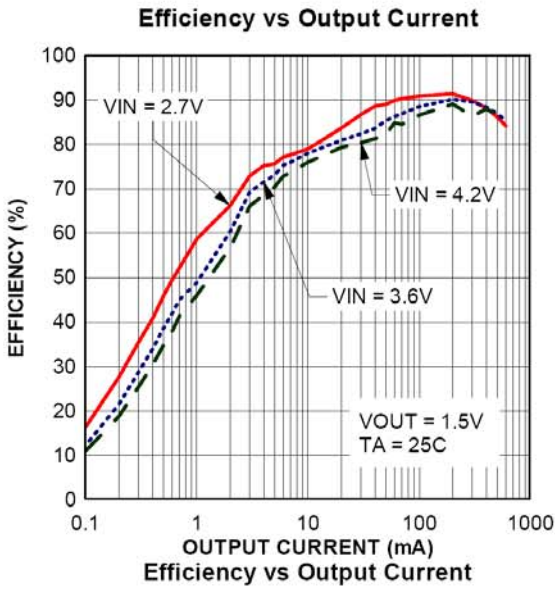
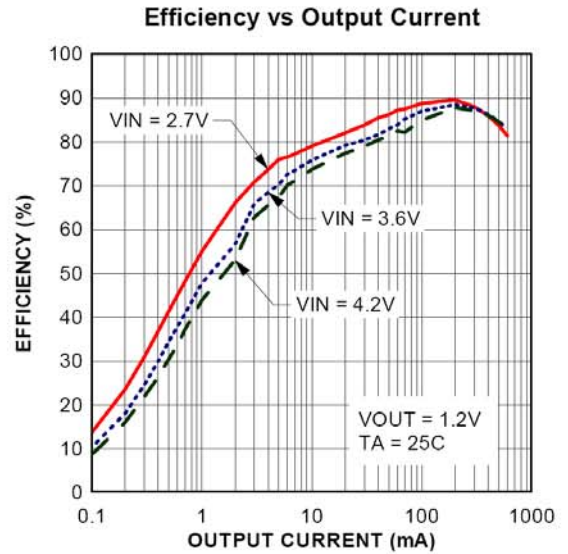
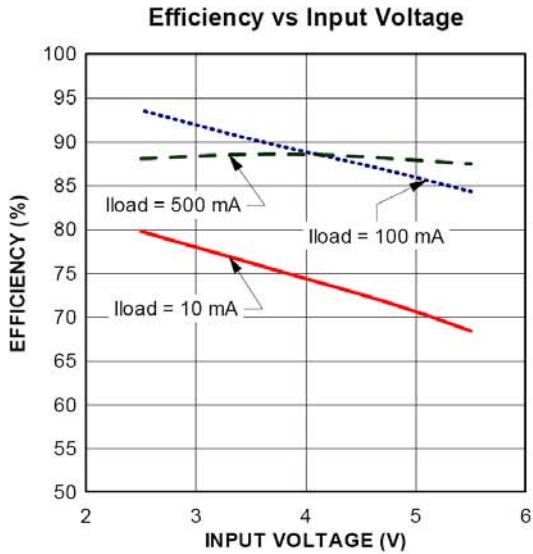

Efficiency vs Load Current

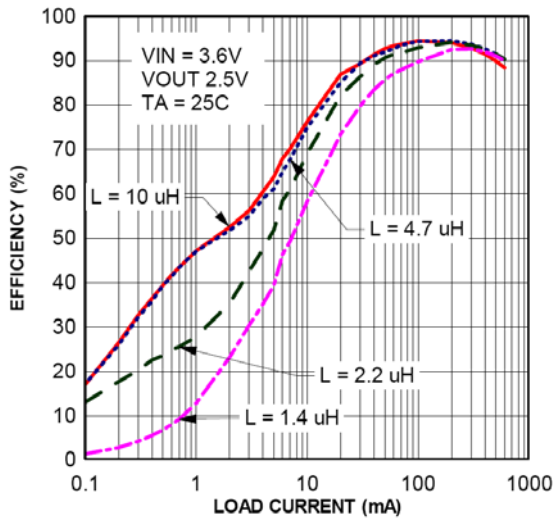

Output Voltage vs Load Current

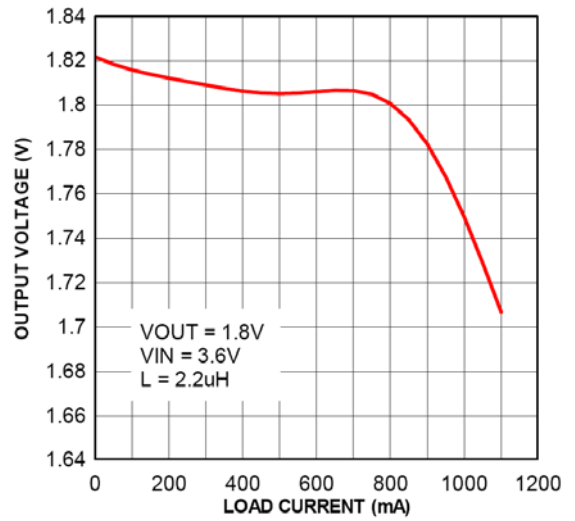

Frequency vs Input Voltage

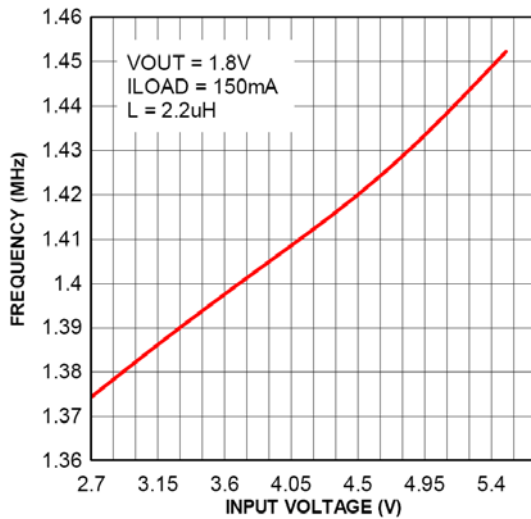

R_{DS(ON)} vs Input Voltage

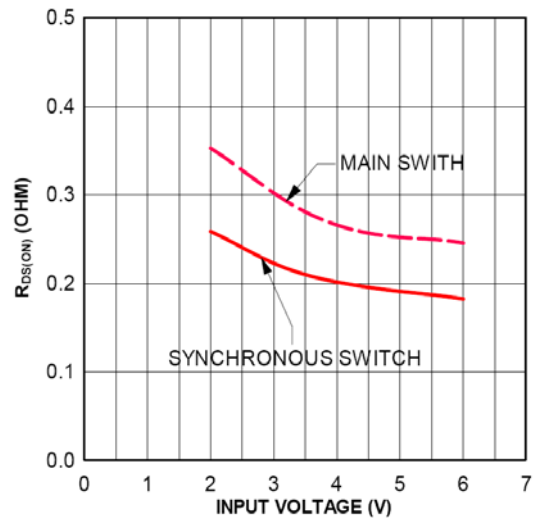

Reference Voltage vs Temperature

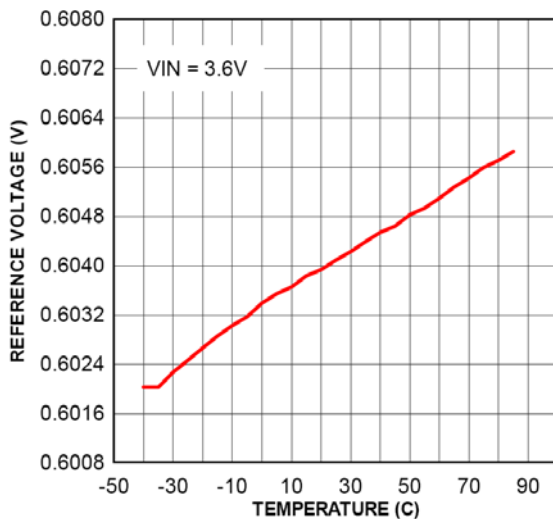

R_{DS(ON)} vs Temperature

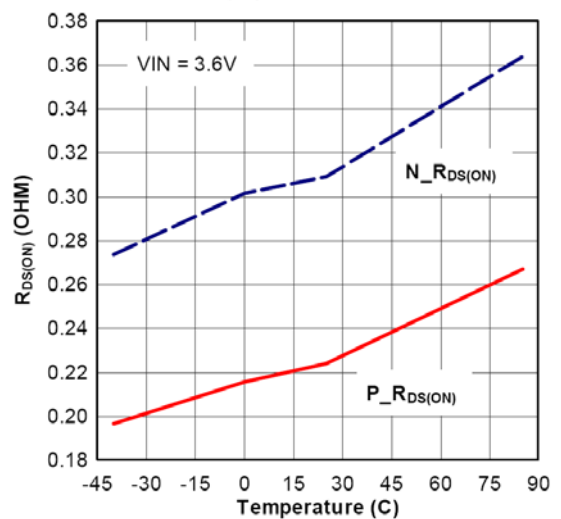

Input Voltage vs Input Current

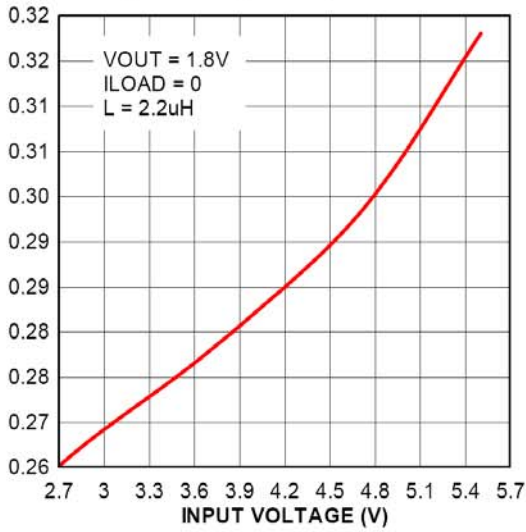

Frequency vs Temperature

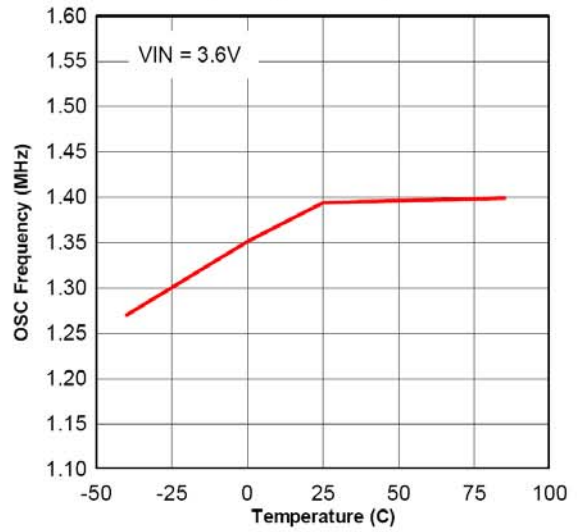

Supply Current vs Temperature

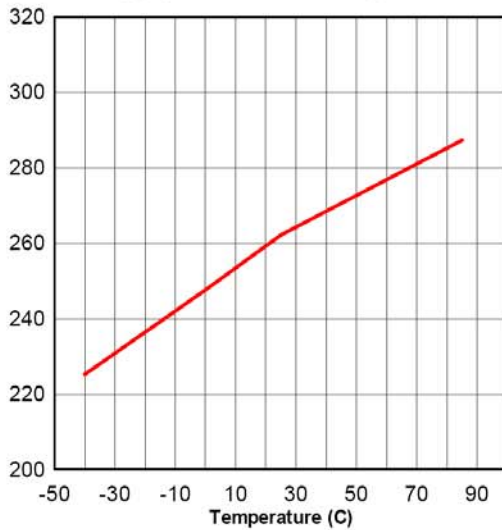

**Load Transient Response
PWM Mode Only**

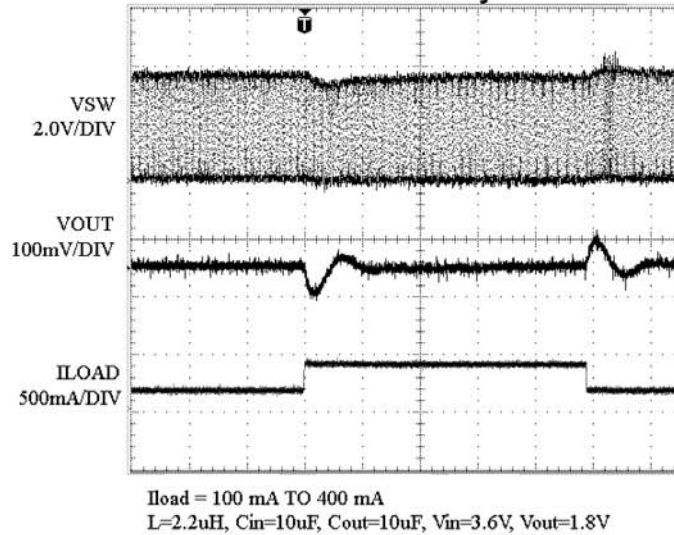

**Load Transient Response
Idle Mode to PWM Mode**

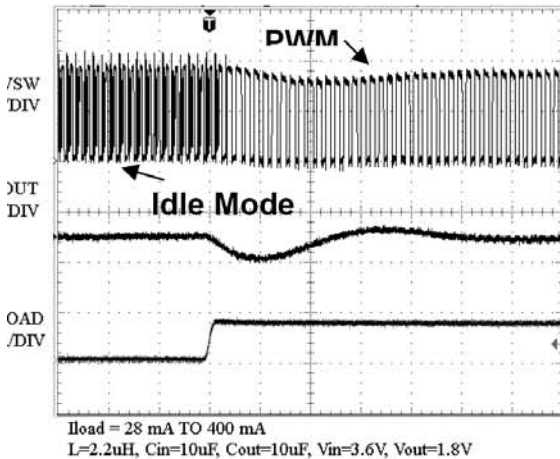

Function Block

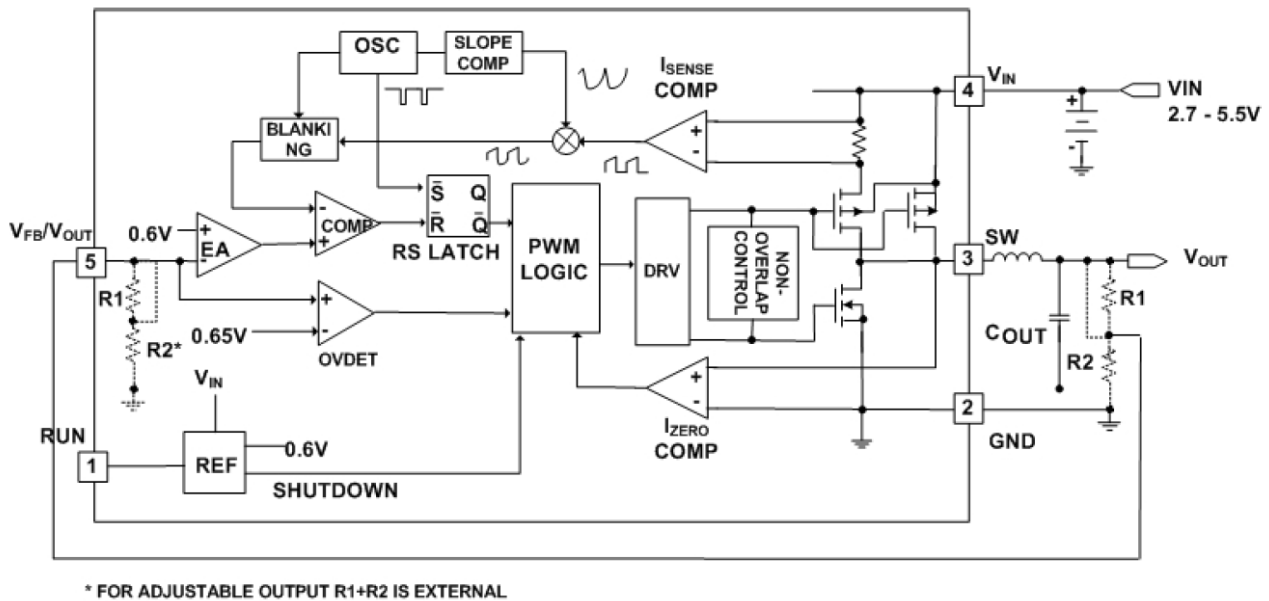

Figure 3: Function Block

Operation

YB1680 is a monolithic switching mode Step-Down DC-DC converter. It utilizes internal MOSFETs to achieve high efficiency and can generate very low output voltage by using internal reference at 0.6V. It operates at a fixed switching frequency, and uses the slope compensated current mode architecture. This Step-Down DC-DC Converter supplies 600mA output current at $V_{IN} = 3V$ with input voltage range from 2.5V to 5.5V.

Current Mode PWM Control

Slope compensated current mode PWM control provides stable switching and cycle-by-cycle current limit for excellent load and line responses and protection of

the internal main switch (P-Ch MOSFET) and synchronous rectifier (N-CH MOSFET). During normal operation, the internal P-Ch MOSFET is turned on for a certain time to ramp the inductor current at each rising edge of the internal oscillator, and switched off when the peak inductor current is above the error voltage. The current comparator, I_{COMP} , limits the peak inductor current. When the main switch is off, the synchronous rectifier will be turned on immediately and stay on until either the inductor current starts to reverse, as indicated by the current reversal comparator, I_{ZERO} , or the beginning of the next clock cycle. The OVDDET comparator controls output transient overshoots by

turning the main switch off and keeping it off until the fault is no longer present.

Idle Mode Operation

At very light loads, the YB1680 automatically enters Idle Mode. In the Idle Mode, the inductor current may reach zero or reverse on each pulse. The PWM control loop will automatically skip pulses to maintain output regulation. The bottom MOSFET is turned off by the current reversal comparator, I_{ZERO} , and the switch voltage will ring. This is discontinuous mode operation, and is normal behavior for the switching regulator.

Dropout Operation

When the input voltage decreases toward the value of the output voltage, the YB1680 allows the main switch to remain on for more than one switching cycle and increases the duty cycle until it reaches 100%. The output voltage then is the input voltage minus the voltage drop across the main switch and the inductor. At low input supply voltage, the $R_{DS(ON)}$ of the P-Channel MOSFET increases, and the efficiency of the converter decreases. Caution must be exercised to ensure the heat dissipated not to exceed the maximum junction temperature of the IC.

$$D = T_{ON} \times f_{OSC} \times 100\% \approx \frac{V_{OUT}}{V_{IN}} \times 100\%$$

Maximum Load Current

The YB1680 will operate with input supply voltage as low as 2.5V, however, the maximum load current decreases at lower input due to large IR drop on the main

switch and synchronous rectifier. The slope compensation signal reduces the peak inductor current as a function of the duty cycle to prevent sub-harmonic oscillations at duty cycles greater than 50%. Conversely the current limit increases as the duty cycle decreases.

Application Information

Setting the Output Voltage

Figure 1 above shows the basic application circuit with YB1680 adjustable output version. The external resistor sets the output voltage according to the following equation:

$$V_{OUT} = 0.6V \times \left(1 + \frac{R2}{R1} \right)$$

$R1=300K\Omega$ for all outputs; $R2=300K\Omega$ for $V_{OUT}=1.2V$, $R2=200K\Omega$ for $V_{OUT}=1.5V$, $R2=150K\Omega$ for $V_{OUT}=1.5V$, and $R=95.3K\Omega$ for $V_{OUT}=2.5V$.

Inductor Selection

For most designs, the YB1680 operates with inductors of $1\mu H$ to $4.7\mu H$. Low inductance values are physically smaller but require faster switching, which results in some efficiency loss. The inductor value can be derived from the following equation:

$$L = \frac{V_{OUT} \times (V_{IN} - V_{OUT})}{V_{IN} \times \Delta I_L \times f_{OSC}}$$

Where ΔI_L is inductor Ripple Current. Large value inductors lower ripple current and small value inductors result in high ripple currents. Choose inductor ripple current

approximately 35% of the maximum load current 600mA, or $\Delta I_L = 210\text{mA}$.

For output voltages above 2.0V, when light-load efficiency is important, the minimum recommended inductor is 2.2 μH . For optimum voltage-positioning load transients, choose an inductor with DC series resistance in the 50m Ω to 150m Ω range. For higher efficiency at heavy loads (above 200mA), or minimal load regulation (but some transient overshoot), the resistance should be kept below 100m Ω . The DC current rating of the inductor should be at least equal to the maximum load current plus half the ripple current to prevent core saturation (600mA+105mA).

Input Capacitor Selection

The input capacitor reduces the surge current drawn from the input and switching noise from the device. The input capacitor impedance at the switching frequency shall be less than input source impedance to prevent high frequency switching current passing to the input. A low ESR input capacitor sized for maximum RMS current must be used. Ceramic capacitors with X5R or X7R dielectrics are highly recommended because of their low ESR and small temperature coefficients. A 4.7 μF ceramic capacitor for most applications is sufficient.

Output Capacitor Selection

The output capacitor is required to keep the output voltage ripple small and to ensure regulation loop stability. The output capacitor must have low impedance at the

switching frequency. Ceramic capacitors with X5R or X7R dielectrics are recommended due to their low ESR and high ripple current. The output ripple V_{OUT} is determined by:

$$\Delta V_{OUT} \leq \frac{V_{OUT} \times (V_{IN} - V_{OUT})}{V_{IN} \times f_{OSC} \times L} \times \left(ESR + \frac{1}{8 \times f_{osc} \times C3} \right)$$

Package Information (SOT23-5)

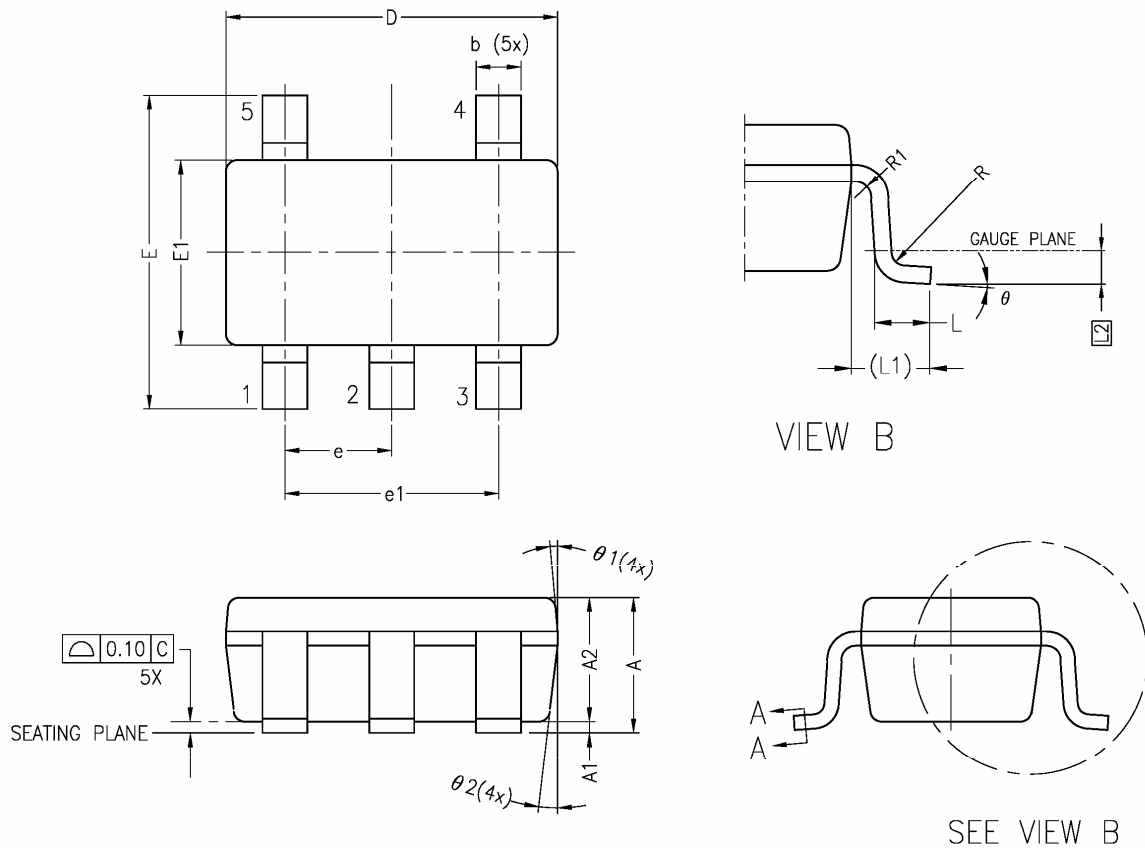

SYMBOLS	DIMENSIONS IN MILLIMETERS		
	MIN	NOM	MAX
A	1.05	1.20	1.35
A1	0.05	0.10	0.15
A2	1.00	1.10	1.20
b	0.35	—	0.50
b1	0.35	0.40	0.45
c	0.08	—	0.22
c1	0.08	0.13	0.20
D	2.80	2.90	3.00
E	2.60	2.80	3.00
E1	1.50	1.60	1.70
e	0.95 BSC		
e1	1.90 BSC		
L	0.35	0.43	0.60
L1	0.60 REF		
L2	0.25 BSC.		
R	0.10	—	—
R1	0.10	—	0.25
θ	0°	4°	8°
θ_1	5°	6°	15°
θ_2	5°	8°	15°

NOTICE:

- The information described herein is subject to change without notice.
- Yobon does not assume any responsibility for use of any circuitry or applications described herein, nor does it convey any patent license.