

# 'Matchless'

# Metal

# Locator

by Thomas Scarborough

An induction balance (IB) metal locator has a good depth of penetration and distinguishes well between ferrous and non-ferrous metals. It is also capable, to a large extent, of rejecting iron and also tin foil. This is a boon for anyone who is searching for coins or noble metals.

My aim with this design was to create a 'minimalist' device — one that would work well but without all the bells and whistles of the expensive, commercial designs. I found that it was possible, with just a handful of components, to design a high-quality metal locator.

For instance, on comparison with the first-class EE-Magenta Buccaneer, this design delivers 95% of the performance in the category where it really matters — a clear indication of the presence of metal.

*Want to find a fortune? Buried treasure, perhaps? Lost coins on the beach? Or perhaps you fancy earning some pocket money finding other people's valuables. Either way, this project should really interest you. It's an el-cheapo induction balance (IB) metal locator that delivers surprisingly good performance.*

### Simple, but it works

An IB metal locator is usually far more complex than the design shown here — the EE-Magenta Buccaneer, for example, uses more than 70 components. This one uses less than 20.

The reason for the simplicity is that I have dispensed with analog circuitry, and instead used a digital transmitter and receiver.

As the search coils pass over metal,

only digital signals of a certain amplitude break through to a peak detector (IC1b). Since these are in the audio range, they are immediately transferred to the piezo sounder or headphones.

On testing the sensitivity of this design in air, with optimal tuning and using a 25mm-diameter brass coin, it gave a clear signal at 150mm, and a 'screaming' signal at 110mm. It was also able to detect a pin at 30mm.

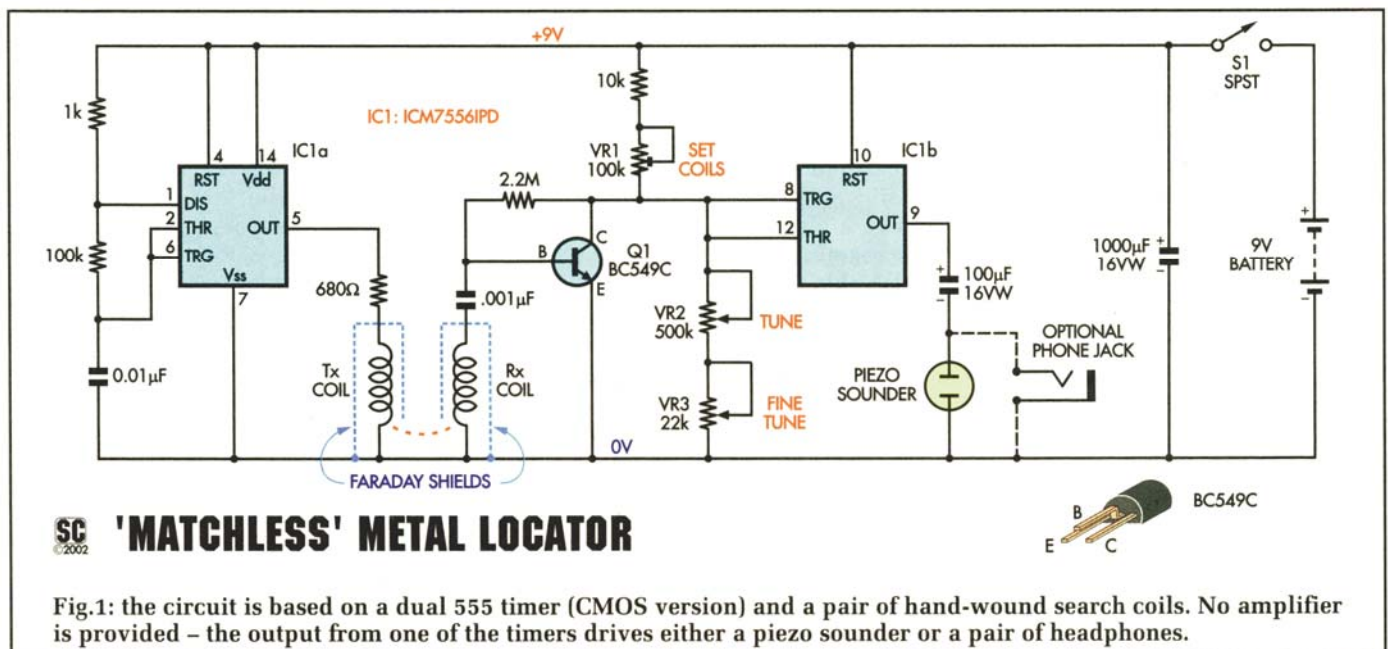

### SC 'MATCHLESS' METAL LOCATOR

Fig.1: the circuit is based on a dual 555 timer (CMOS version) and a pair of hand-wound search coils. No amplifier is provided – the output from one of the timers drives either a piezo sounder or a pair of headphones.

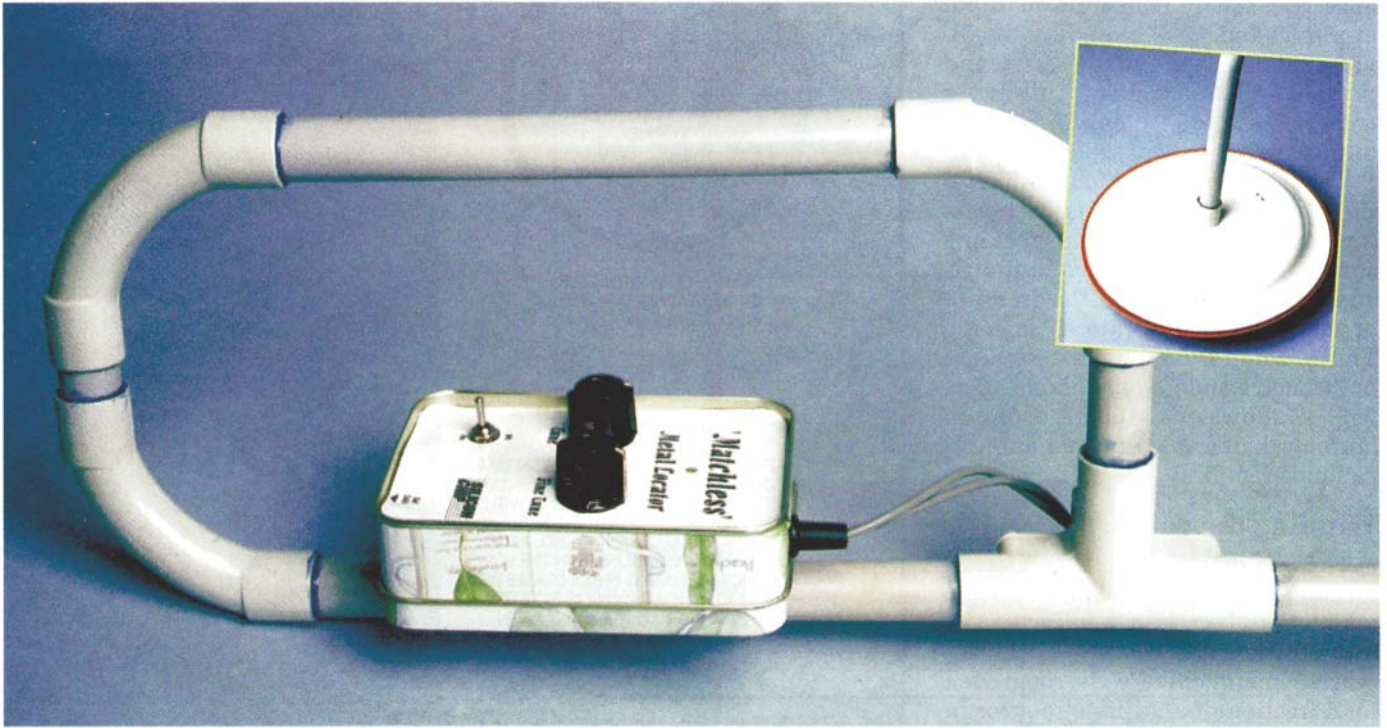

The two “business ends” of the metal detector: the electronics box at the top end, mounted on 20mm PVC pipe, with the inset showing the search coils at the bottom end, potted and mounted in plastic dinner plates.

Note that these figures may not apply in the ground, where depth of penetration will depend largely on the mineralisation present.

In contrast, the locator is far more reluctant to pick up tin foil. A tin foil disk of the same size as the brass coin was only detected at half the distance in

air. This rejection of tin foil is due in part to the metal locator’s low frequency, which avoids what is called skin effect.

Besides this, if the two coils are positioned as described, ferrous metals (iron) are, to a very large extent, rejected — to such an extent, in fact, that a 25mm diameter brass coin weighing seven grams looks the same to the metal locator as a lump of iron weigh-

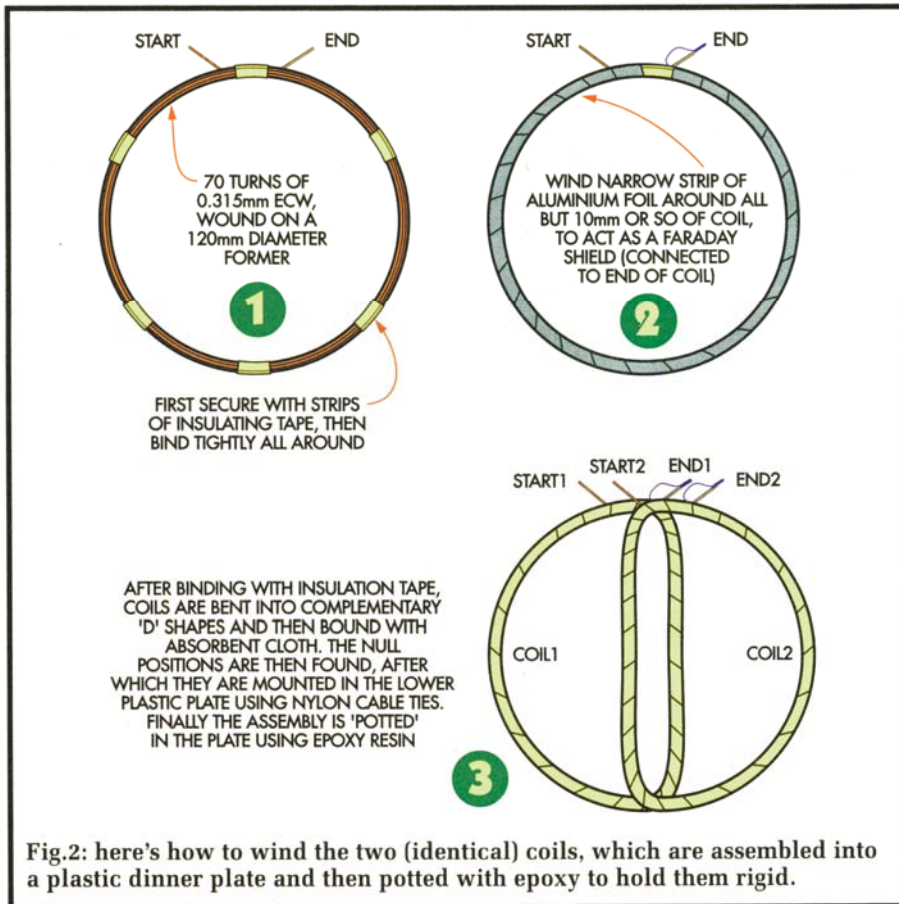
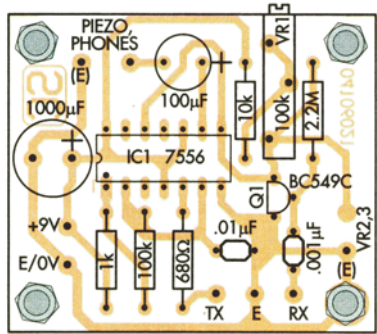

Fig.2: here's how to wind the two (identical) coils, which are assembled into a plastic dinner plate and then potted with epoxy to hold them rigid.



This photo clearly shows the potted search coils in situ.





**Fig.3: the PC board isn't very big – and there's not much on it!**

ing 20 times as much. Large nonferrous objects are detected at half a metre distance and more.

The locator's power consumption is conveniently low. It draws around 10mA, which means that it may be powered off a small 9V battery. If an alkaline battery is used, this will provide about 48 hours' continuous use. In my experience, the number of coins that are found on a beach in an hour or two should easily make up for the cost of batteries!

Finally, while the stability of the locator is not the best, it's by no means the worst either. Re-tuning is necessary from time to time, especially in the first few minutes of use. One soon becomes accustomed to giving the Fine Tune knob an occasional tweak — perhaps with every 40 or 50 sweeps of the search head.

**Circuit description**

The search head of a typical IB metal locator contains two coils: a transmitter (Tx) coil and receiver (Rx) coil.

In this case, the Tx coil is driven by a square wave oscillator, which sets up an alternating magnetic field in the coil. The Rx coil is then positioned in such a way that it partly overlaps the Tx coil. By adjusting the amount of overlap, a point can be found where the voltages in the Rx coil 'null' or cancel out, so that little or no electrical output is produced. A metal object which enters the field then causes an imbalance, resulting in a signal.

The transmitter (IC1a) is a standard 555 oscillator configuration, using one half of the ICM7556IPD dual low power CMOS version of this IC.

Do NOT use the veteran NE556N IC, by the way.

IC1a oscillates at about 700Hz, determined by R/C components around pins 1, 2 and 6. The 680Ω resistor limits the current passing through the Tx coil.

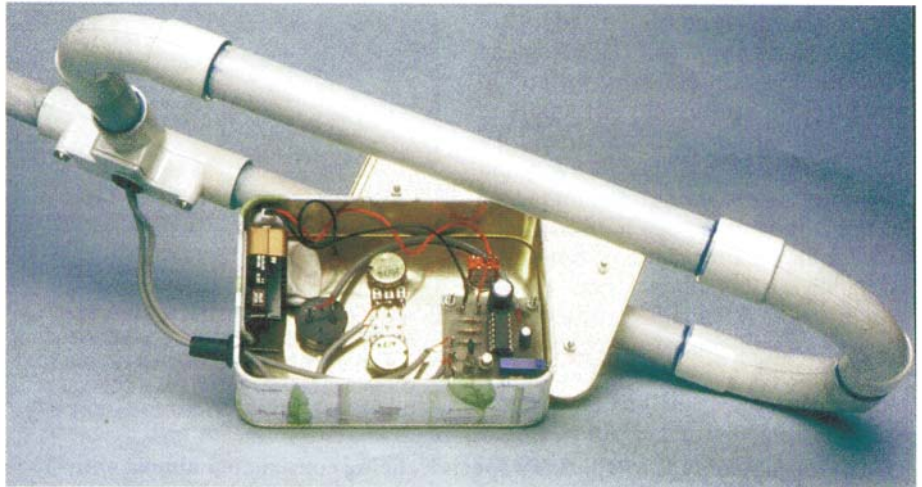

Use this photograph with the component overlay at left and the wiring diagram below to help locate the various bits in their box.

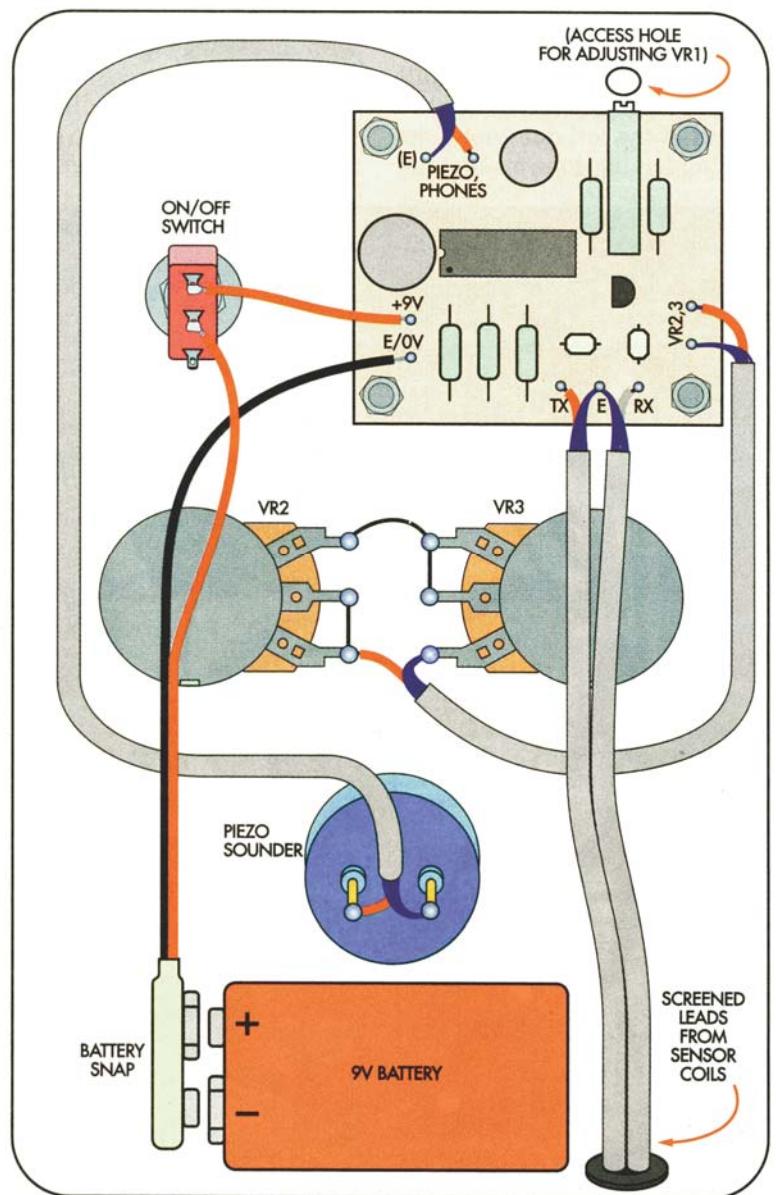

**Fig.4: apart from the coils, it's all assembled in a lolly tin (fair dinkum!). Don't forget to eat the contents first.**



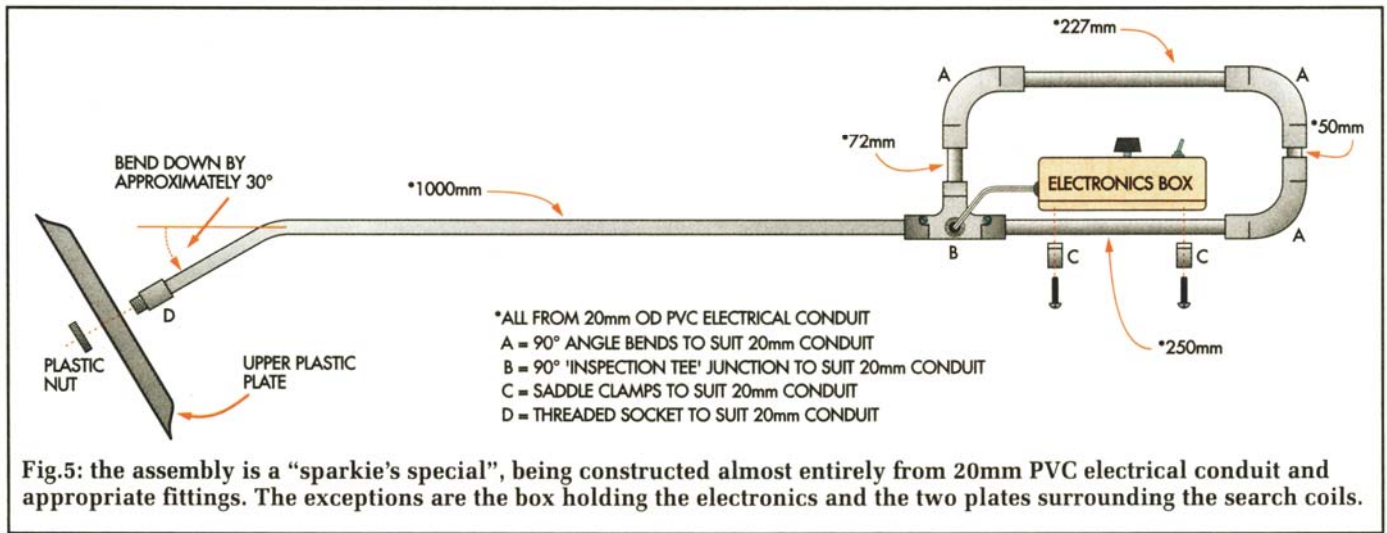

The receiver section (IC1b) is preceded by a simple yet sensitive preamplifier stage, based on Q1, which amplifies the signal received from the Rx coil. This is fed directly to IC1b, which is used here as a high-performance sine-square convertor. Its input

at pins 8 and 12 is biased by the divider formed by the 10kΩ resistor and pots VR1-VR3, so that only pulses of a certain amplitude break through to output pin 9.

There is a point at which, with careful adjustment, the signal is just

breaking through in the form of a crackling sound. When the locator’s output is adjusted to a fast crackle, the presence of metal turns this into a ‘scream’. This is heard from the piezo sounder or through standard headphones. The 7556 IC allows up to 100mA of output current, therefore no further amplification is required.

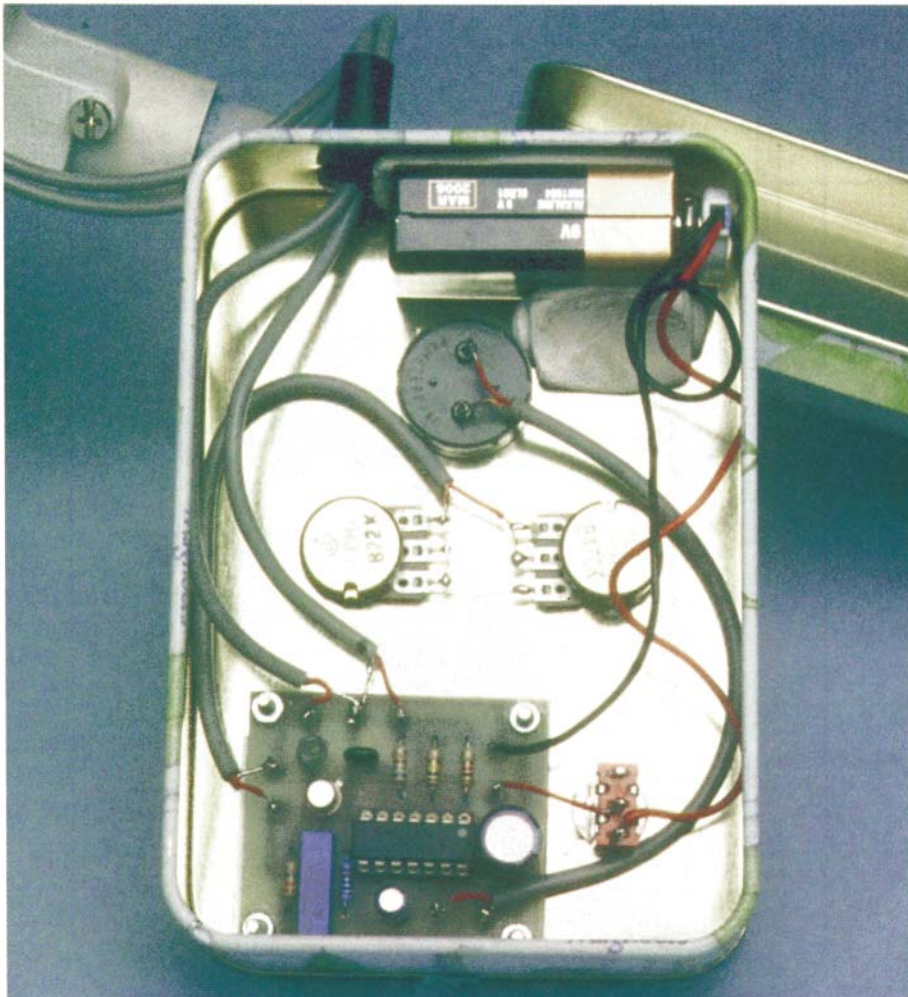

Another view looking into the electronics box, this time from the other side up, or “ander kant bo” as they would say in Afrikaans.

### Winding the coils

The one drawback to any IB metal locator design is its need for two coils, which must be very carefully and rigidly positioned in relation to one another. Sometimes there’s no room even for a fraction-of-a-millimetre error in positioning these coils. While this particular design makes things easier than usual, the placement of the coils will still require some patience. On the other hand, the winding of the coils is relatively easy. Each coil also includes an electrostatic (Faraday) shield, which helps to minimise ground effect.

The winding of the (identical) coils is not critical and a little give and take is permissible.

I used 30SWG (0.315mm) enamelled copper wire, winding 70 turns on a circular former, 120mm in diameter.

I created the former with a sheet of stiff cardboard with 12 pins stuck through it at a suitable angle (the heads facing slightly outwards). The coil was wound clockwise around the pins, then temporarily held together with stubs of insulating tape passed under the coil and pressed together over the top. The coil may be jumble-wound (that is, you don’t have to wind the turns on side-by-side in neat layers).

Once this has been done, the pins are removed, and a second coil is wound in



## Parts List – Matchless Metal Locator

- 1 PC board, code 04106021, 48 x 42mm
- 1 9V battery, preferably alkaline
- 1 9V battery snap lead
- 1 Piezo sounder
- 1 Metal case to suit, approx 130 x 90 x 40mm
- 2 Rigid plastic dinner plates
- 1 3.5mm chassis mount mono jack socket (optional)
- 1 14-pin DIL IC socket (optional)
- 4 M2.5 10mm bolts
- 8 M2.5 nuts
- 1 Rubber grommet
- 1 Large front-panel knob
- 1 Small front-panel knob
- 9 1mm diameter PC solder pins
- 1 On-off switch for mounting in circular hole
- 30SWG (0.315mm) enamelled copper wire
- Nylon cable ties
- Dishwasher cloth cut to 20mm strips (eg, "Chux")
- Aluminium or tin foil cut to 20mm strips
- PVC piping, joints, nuts and bolts as required (see Fig.3)











### Semiconductors

- 1 ICM7556IPD dual CMOS timer IC (no substitutes)
- 1 BC549C bipolar transistor or close equivalent

### Capacitors

- 1 1000µF 16VW PC electrolytic
- 1 100µF 16VW PC electrolytic
- 1 0.01µF disc ceramic (code 10n or 103)
- 1 .001µF polystyrene (code 1n or 102)

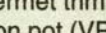
### Resistors (0.25W 5%)

- |  |   |    |   |  |
|--|---|----|---|--|
|  | (4-band)  |    | (5-band)  |  |
| 1 2.2MΩ                                |  | OR |  |  |
| 1 100kΩ                                |  |    |  |  |
| 1 10kΩ                                 |  |    |  |  |
| 1 1kΩ                                  |  |    |  |  |
| 1 680Ω                                 |  |    |  |  |
| 1 100kΩ multiturn cermet trimmer (VR1) |   |    |   |  |
| 1 470kΩ linear carbon pot (VR2)        |   |    |   |  |
| 1 22kΩ linear carbon pot (VR3)         |   |    |   |  |

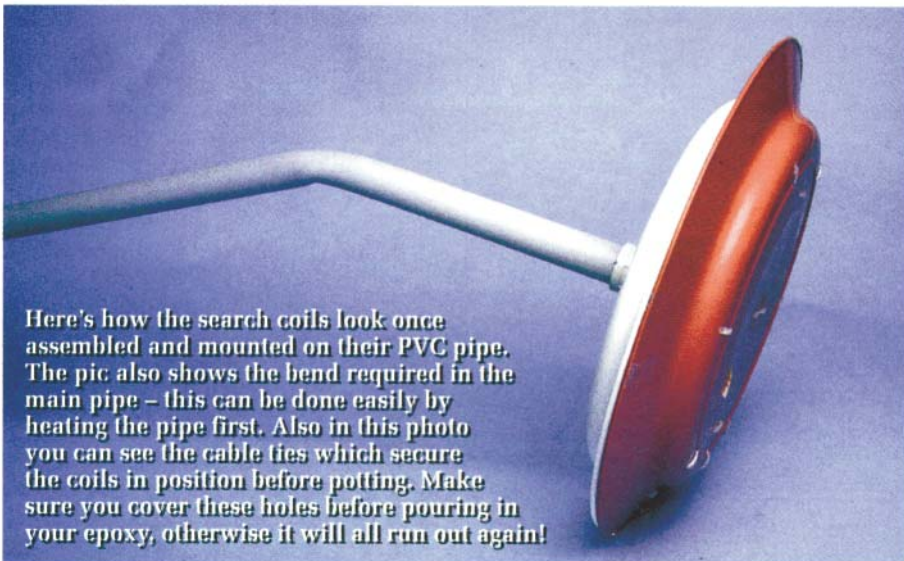

Here's how the search coils look once assembled and mounted on their PVC pipe. The pic also shows the bend required in the main pipe – this can be done easily by heating the pipe first. Also in this photo you can see the cable ties which secure the coils in position before potting. Make sure you cover these holes before pouring in your epoxy, otherwise it will all run out again!

the same way. In each case, mark the beginning and end wires. Each coil is then tightly bound by winding insulating tape around its entire circumference.

Now we add a Faraday shield to each coil. This is accomplished with some long, thin strips of aluminium foil. First scrape the enamel off each coil's end wire. Solder a 100mm length of bare wire to the winding wire, and twist this around the coil, over the insulating tape. This provides electrical contact for the Faraday shield.

Beginning at the base of this lead, the foil is wound around the circumference of the coil, so that no insulating tape is still visible under the foil but the foil should not complete a full 360°. Leave a small gap (say 10mm) so that the end of the foil does not meet the start after having gone most of the way around. Do this with both coils. Each coil is now again tightly bound with insulating tape around its entire circumference.

Attach each of the coils to its own length of quality single-core screened audio cable, with the Faraday shield in each case being soldered to the screen. Do not use stereo or twin-core microphone wire to run both leads together; this may cause interference between the coils.

Gently bend the completed coils until each one is reasonably flat and circular, with each end wire facing away from you, and to the right of the beginning wire. Now bend them further until they form lopsided ovals like capital Ds (see Fig.2). The backs of the Ds overlap each other slightly in the centre of the search head. This is the critical part of the operation, which we shall complete after having constructed the circuit.

Last of all, wind strips of absorbent cloth around each coil (I used strips of thin dishwashing cloth such as Chux), using a little all-purpose glue to keep them in place. Later, when epoxy resin is poured over the coils, this cloth

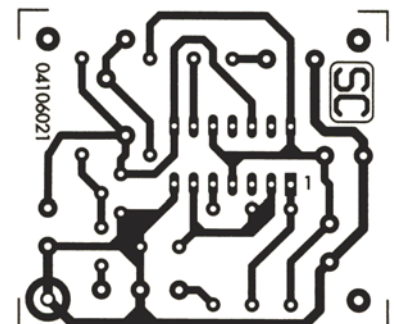

Fig.6: same-size PC board artwork in case you want to etch-your-own!



meshes the coils into the resin.

### Construction

The PC board of the Matchless Metal Locator measures 48mm x 42mm, and is coded 04106021. There are not many components, so it should be easy to assemble the board using the PC board overlay diagram in Fig.3.

With the exception of the CMOS IC, component values and types are not critical. The one critical component is the ICM7556IPD CMOS IC. I also tried the TS556CN IC in this position — it worked, but not as well.

Begin board assembly by soldering the nine terminal pins, the 14-pin dual-in-line socket for IC1 and the resistors. Continue with the capacitors, diodes and Q1.

Once soldering is complete, carefully check the board for any solder bridges, then use some short lengths of quality screened microphone wire to attach the piezo sounder, VR2 and VR3, with the screen (or braid) always being wired to 0V. If you wish, add a socket for headphones in parallel with or in place of the piezo sounder. Use insulated hookup wire to attach the battery and switch S1, keeping the leads short. Finally, attach the screened cables from the coils, with the screen again going to 0V, and insert IC1 in the DIL socket. Note that IC1 is static sensitive, and requires careful handling (discharge your body to earth before handling).

Fig.5 shows the suggested hardware

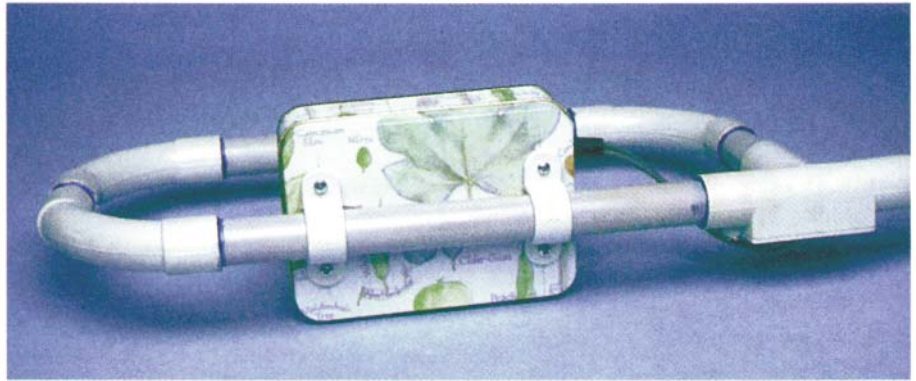

This photo gives you a better idea of how the electronics box is mounted to the main PVC pipe. Ordinary saddle clamps hold it in place. Town) but found that good quality metal sweet tins were readily available, so I used one of these. They are also considerably cheaper than similarly sized electronics enclosures and of course you get the sweets as well!

### Setting the coils

A completed PC board is needed before we can 'pot' the coils. These are potted with epoxy resin in a hard plastic dinner plate, the sort you'd find in a picnic set. Any plastic plate of suitable size will do, on condition that it is rigid.

(A tip: don't pinch them from the family picnic set ....)

First place the coils on top of one another — ensuring that they are correctly orientated, with each end wire facing away from you, and to the right of the beginning wire. Adjust both VR2 and VR3 to their midpoint. Adjust VR1 to about 90kΩ. Then attach a 9V battery and switch on. The circuit will most likely be screaming; that is, beeping loudly and continuously.

Now slowly move the coils apart. When they are somewhere past the halfway point, the headphones will fall silent. This is where the voltages in the Rx coil 'null'. Continue to move the coils apart. At a precise point just before the coils no longer overlap at all — the headphones will begin to scream again (there may or may not be a low-level beep just before this).

It is at this precise point, and not a fraction of a millimetre either way, that the coils need to be set.

Take an indelible marker pen and mark out holes in the lower plate around both coils. These holes are used to pass cable ties through, to hold the coils tightly to the plate. Also use a cable tie to hold the audio cables to the plate. Use some Blu-tak

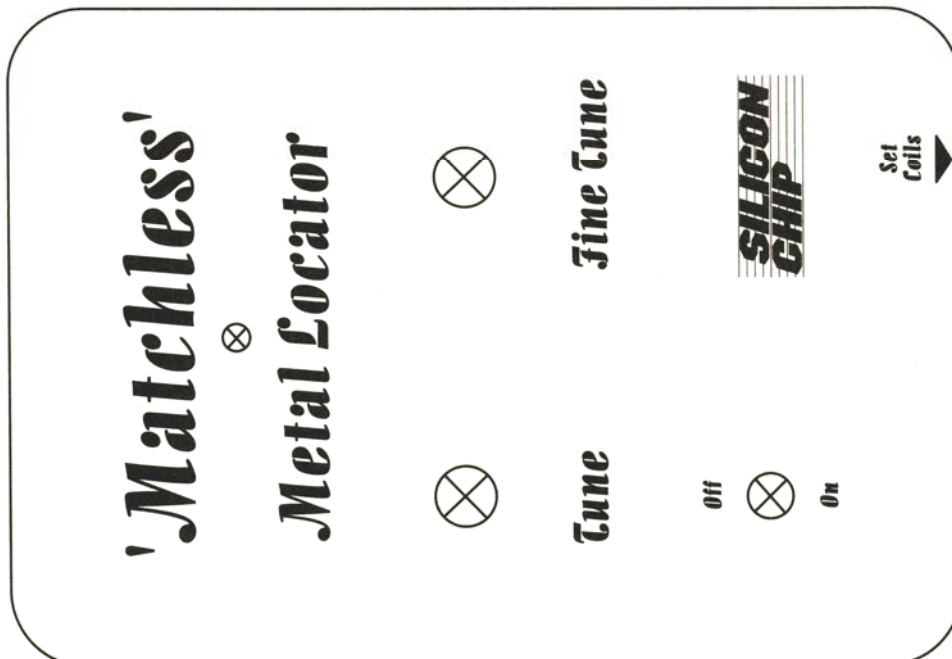

Fig.7: here's the same-size front panel artwork. Use a photocopy to act as a template when drilling the case.

(or Presstik) to tightly seal the holes underneath the plate before pouring in the resin — epoxy resin can be very ‘runny’ and sticks faster than many glues.

Also at this point carefully bend the coils at the centre of the plate until you reach the exact balance at which there is neither silence nor screaming in the piezo sounder/headphones, but just a crackle. A little drift should not matter at this point.

Now you are ready to mix and pour the resin. Use a modest amount of catalyst, so that there will be not too much heat and shrinkage in the resin. Pour the resin over the cloth which surrounds the coils, so as to soak it, and keep on pouring at least until the entire bottom of the plate is covered with resin.

The circuit may no longer function correctly at this point until the resin has

hardened, so make no more adjustments at this stage, but switch the circuit off and leave it for 24 hours or so.

I potted two sets of coils (that is, two complete search heads). The first worked perfectly, precisely as I had set it in the plate. The second contracted slightly as the resin set, so that no settings of VR2 or VR3 would produce a tone in the headphones. However, this is where the design of the Matchless Metal Locator shows its flexibility. By turning VR1 clockwise, the circuit was again functioning normally when VR2 and VR3 were set to their midpoint.

### How to use it

Keep the search head away from all metal — and “noisy” computer equipment — and switch on. Adjust potentiometers VR2 (Tune) and VR3

(Fine Tune) to their mid-points. Then adjust VR1 with a screwdriver or plastic alignment tool until the metal locator is just at the point where a crackle is heard, between silence and a scream (or between a low-level hum and a scream). Use the tune and fine-tune knobs for any further tuning.

A fast crackling sound produces the best results. Move a coin over the search head and the piezo sounder should scream.

In actual use, the adjustment of the metal locator will be affected by the mineralisation of the ground you are searching, as well as temperature and voltage variations. So as mentioned earlier, readjustments to VR3 and VR2 are inevitable from time to time.

That’s really all there is to it. In case of any problems, though, the author may be contacted at [scarboro@iafrica.com](mailto:scarboro@iafrica.com).