

Ultra High Precision Industrial Grade with the Second Generation of Z-Foil (Z1-Foil) Molded Surface Mount Resistor with TCR down to $\pm 0.5 \text{ ppm}/^\circ\text{C}$ Maximum, PCR of $\pm 5 \text{ ppm}$ at Rated Power, Flexible Terminations, and Load Life Stability of $\pm 0.005 \%$ (50 ppm)

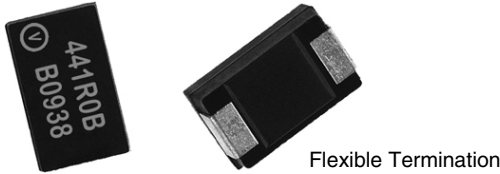

Flexible Termination

INTRODUCTION

Flexible Terminations with Zero TCR

Vishay's new flexible termination resistor with the second generation of Z-Foil (Z1-Foil) features new orders of accuracy, stability and speed in a size small enough for permanent assembly in operational equipment.

It is well known that chips of 1206 and larger dimensions occasionally delaminate from the printed circuit board or develop cracks. This is due to stresses introduced into the chip by handling of the PC board and stress due to thermal shock.

Vishay has introduced a chip in a molded package with flexible terminations which does not change due to the above, i.e. no cracks and no separation from the board.

The SMR3P is the industry's lowest absolute TCR, thus reducing a major source of uncertainty in precision circuits. The SMR3P can withstand unconventional environmental conditions, including the extremely high temperatures and radiation-rich environments of down-hole oil exploration and well logging, or the deep-sea underwater repeaters in cross-ocean communications. The exceptionally-low TCR of the new Z-Foil Bulk Metal® Foil resistor derives from an elegant balance of metallurgical resistivity and temperature-induced compressive force.

The SMR3P comes with a Load Life Stability certificate:

The Bulk Metal Z-Foil resistor has documented the most precise load-life stability of any resistor. That's because the resistance element is a Bulk Metal Z-alloy that has been applied to a substrate with a unique formation of a resistive pattern that is maintained stress-free through the balance of the process, including termination welding, encapsulation, marking, curing, etc. Coatings between the element and the external case isolate the element from external stresses. The flat planar foil very efficiently transmits heat to the substrate and dissipates it through the leads and through the package body. The SMR series of surface-mounts has the further advantage of flexible terminations to isolate the element from repetitive expansions and contractions of the board, thereby assuring even better long-term stability. Moreover, all Vishay Bulk Metal Foil resistors are rated to maintain rated stability at full rated power and temperature. So it is not necessary to de-rate the foil resistors in application.

Application includes:

1. Secondary standards
2. Feedback devices for operational amplifiers
3. Precision voltage dividers
4. Precision bridge resistors
5. Decade voltage dividers

Our application engineering department is available to advise and make recommendations. For non-standard technical requirements and special applications, please contact us.

FEATURES

- Temperature coefficient of resistance (TCR): $\pm 0.5 \text{ ppm}/^\circ\text{C}$ maximum (+ 25 °C to + 125 °C)
- Tolerance: to $\pm 0.01 \%$
- Power coefficient of resistance (PCR) "ΔR due to self heating": 5 ppm at rated power
- Flexible terminations ensure minimal stress transference from the PCB due to load induced temperature gradients and a difference in thermal coefficient of expansions (TCE)
- Electrostatic discharge (ESD) up to 25 000 V
- Load life stability: $\pm 0.005 \%$ (70 °C, 2000 h at rated power)
- Resistance range: 100 Ω to 15 kΩ
- Vishay Foil resistors are not restricted to standard values; specific "as-required" values can be supplied at no extra cost or delivery (e.g. 1K0002 vs. 1K)
- Power rating: to 600 mW at 70 °C
- Non-inductive, non-capacitive design
- Current noise: 0.010 μV_{RMS}/V of applied voltage (< - 40 dB)
- Voltage coefficient: < 0.1 ppm/V
- Non-inductive: < 0.08 μH typical
- Thermal stabilization time < 1 s (nominal value achieved within 10 ppm of steady state value)
- Pattern design minimizing hot spots
- Terminal finish: lead (Pb)-free or tin/lead alloy
- Matched sets with TCR tracking are available upon request
- For better performances please contact us
- Prototype quantities available in just 5 working days or sooner. For more information, please contact foil@vishaypg.com
- Compliant to RoHS directive 2002/95/EC



RoHS*
COMPLIANT

APPLICATIONS

- Precision amplifiers
- High precision instrumentation
- Medical
- Automatic test equipment (ATE)
- Industrial
- Audio (high end stereo equipment)
- EB application
- Pulse application
- Measurement instrumentation

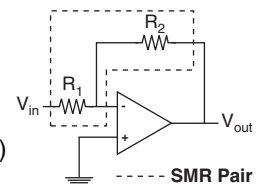

TABLE 1 - TOLERANCE AND TCR VS. RESISTANCE VALUE (1)

| VALUE | TIGHTEST TOLERANCE | MAXIMUM TCR (ppm/°C) (+ 25 °C to + 125 °C) | MAXIMUM TCR (ppm/°C) (- 55 °C to + 25 °C) |
|----------------|--------------------|--|---|
| 100 Ω to 15 kΩ | $\pm 0.01 \%$ | ± 0.5 | ± 2 |

Note

(1) Tighter performances are available

* Pb containing terminations are not RoHS compliant, exemptions may apply

FIGURE 1 - POWER DERATING CURVE

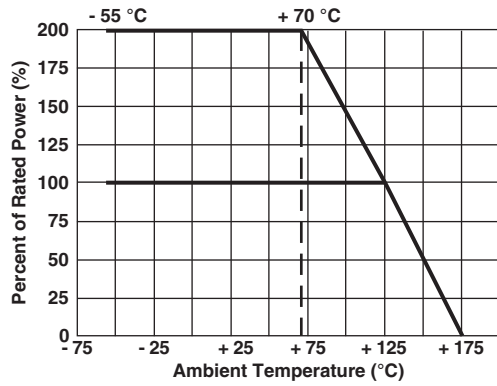

FIGURE 2 - TRIMMING TO VALUES
(conceptual illustration)

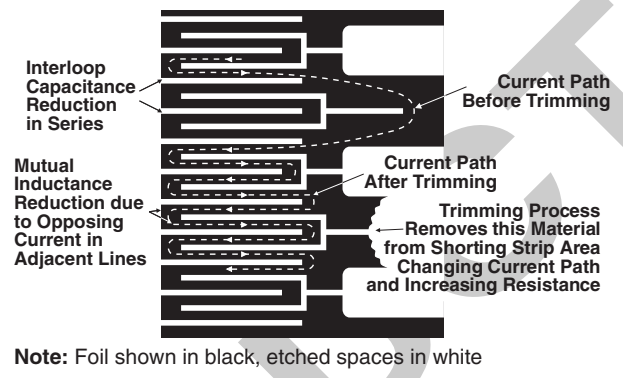
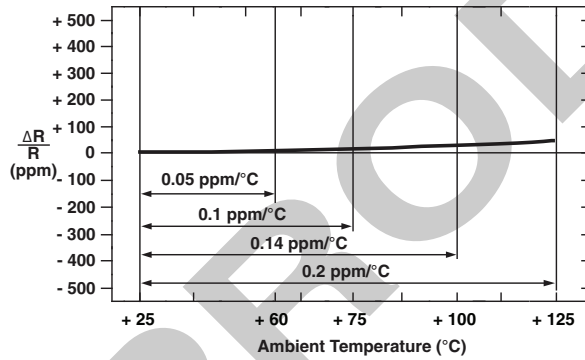

FIGURE 3 - TYPICAL TCR CURVE Z-FOIL



Note

- For more details, see table 1

FIGURE 4 - THERMAL EXPANSION

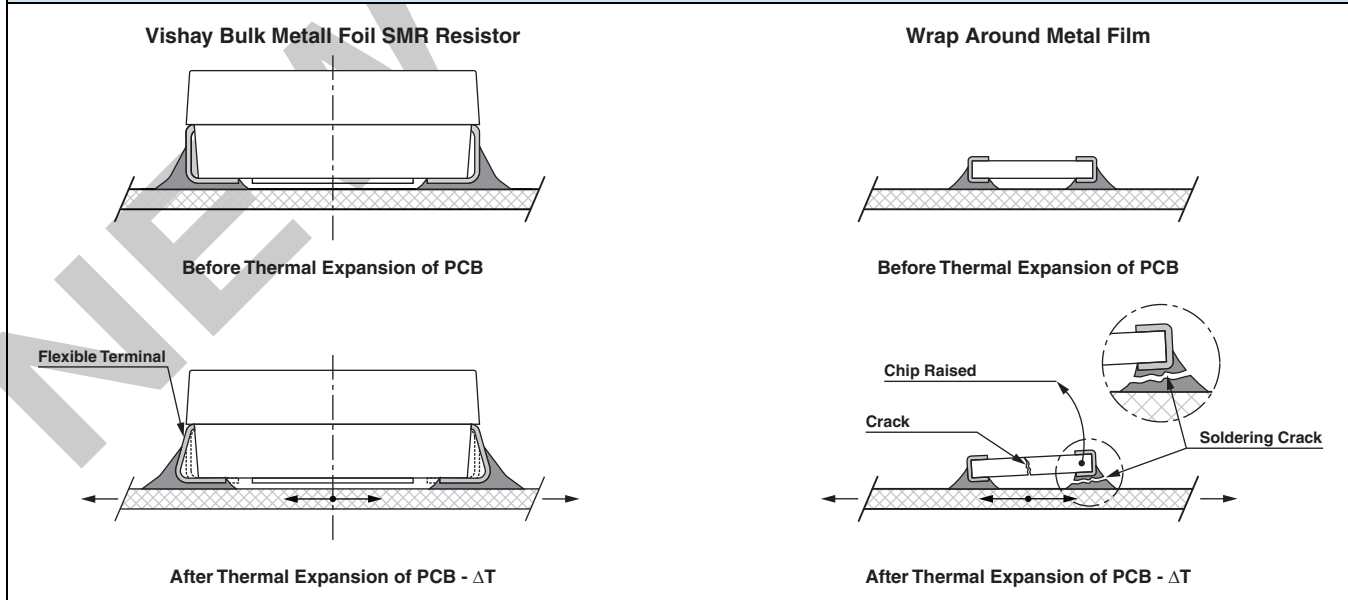

TABLE 2 - SMR3P PERFORMANCE SPECIFICATIONS

| TEST | CONDITIONS | MAXIMUM LIMIT (1) |
|---------------------------------------|--|---|
| Resistance Range | | 100 Ω to 15 kΩ |
| Rated Power | 100 Ω to 15 kΩ; 0.6 W at 70 °C; 0.3 W at 125 °C | See figure 1 |
| Maximum Working Voltage | | 180 V |
| Maximum Operating Temperature | + 175 °C (see figure 1) | |
| Working Temperature Range | - 55 °C to + 125 °C (MIL range) | |
| Thermal Shock | - 65 °C to + 150 °C; 30 min; 5 cycles | ± 0.01 % (100 ppm) |
| Short Time Overload | 6.25 x rated power; 5 s | ± 0.01 % (100 ppm) |
| Low Temperature Storage | - 65 °C, 24 h | ± 0.01 % (100 ppm) |
| Low Temperature Operation | 45 min at rated power at - 65 °C | ± 0.01 % (100 ppm) |
| Dielectric Withstanding Voltage (DWV) | Atmospheric pressure; AC 200 V; 1 min | ± 0.01 % (100 ppm) |
| Insulation Resistance (MΩ) | DC 100 V; 1 min | over 10 000 |
| Resistance to Soldering Heat (%) | 260 °C; 10 sec | ± 0.02 % max., ± 0.01 % typ. |
| Moisture Resistance | + 65 °C to - 10 °C; 90 % to 98 % RH; rated power; 240 h | ± 0.02 % (200 ppm) |
| Shock | 100 G; sawtooth at 6 ms | ± 0.01 % (100 ppm) |
| Vibration, High Frequency | 10 Hz to 2000 Hz to 10 Hz; 20 G | ± 0.01 % (100 ppm) |
| Load Life Stability (2000 h) | 0.15 W at + 70 °C 0.6 W at + 70 °C 0.3 W at + 125 °C | ± 0.002 % typ., ± 0.01 % max. ± 0.005 % typ., ± 0.015 % max. ± 0.005 % typ., ± 0.015 % max. |
| Load Life Stability (10 000 h) | | ± 0.005 % typ., ± 0.015 % max. ± 0.015 % typ., ± 0.05 % max. ± 0.015 % typ., ± 0.05 % max. |
| High Temperature Exposure | 175 °C; no load 2000 h | ± 0.05 % (500 ppm) |
| Weight | | 0.244 g |
| Packaging | Bulk (loose) or tape and reel, per EIA-481-1 | |

Note

(1) As shown + 0.01 Ω to allow for measurement error at low values

FIGURE 4 - DIMENSIONS in inches (millimeters)

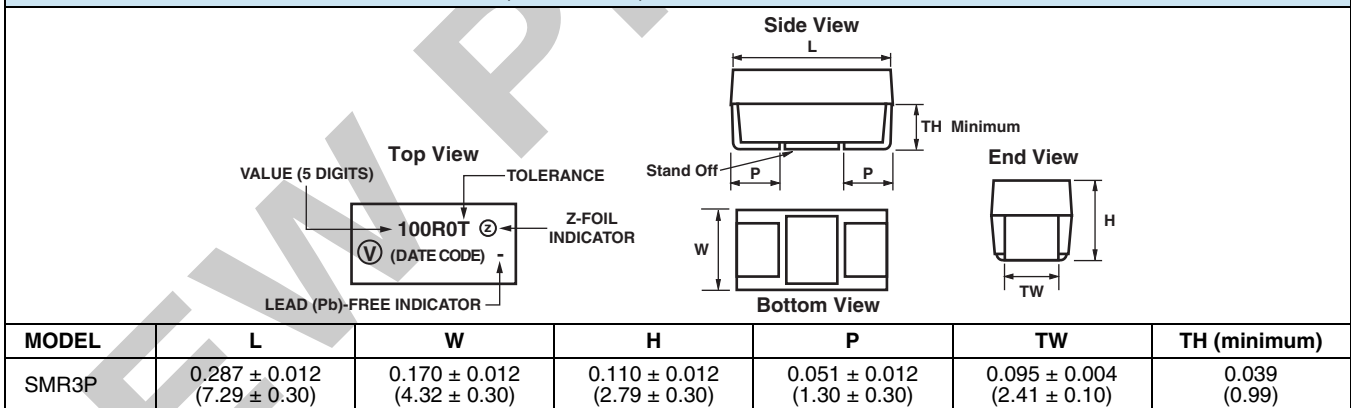

FIGURE 5 - RECOMMENDED MOUNTING PAD GEOMETRIES in inches (millimeters)

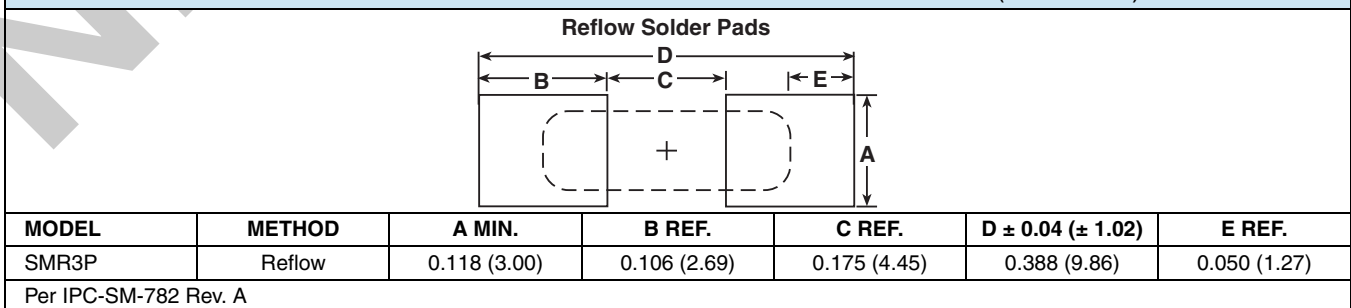
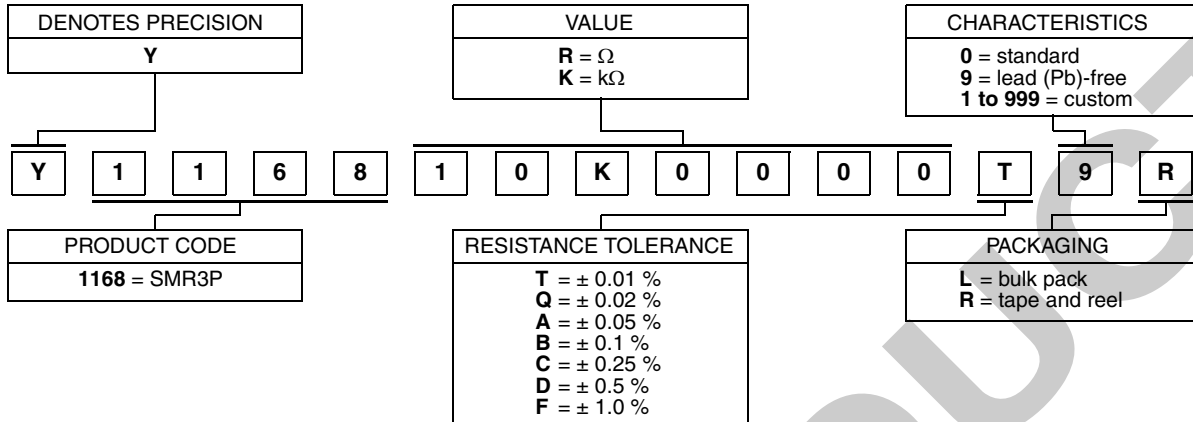

TABLE 3 - GLOBAL PART NUMBER INFORMATION (1)

NEW GLOBAL PART NUMBER: Y116810K0000T9R (preferred part number format)



FOR EXAMPLE: ABOVE GLOBAL ORDER Y1168 10K0000 T 9 R:

TYPE: SMR3P

VALUE: 10.0 $k\Omega$

ABSOLUTE TOLERANCE: $\pm 0.01\%$

TERMINATION: Lead (Pb)-free

PACKAGING: Tape and reel

HISTORICAL PART NUMBER: SMR3P 10K000 TCR0.2 T S T (will continue to be used)

| SMR3P | 10K000 | TCR0.2 | T | S | T |
|-------|----------------|--------------------|---|------------------------------------|------------------------------------|
| MODEL | OHMIC VALUE | TCR CHARACTERISTIC | RESISTANCE TOLERANCE | TERMINATION | PACKAGING |
| SMR3P | 10.0 $k\Omega$ | | T = $\pm 0.01\%$ Q = $\pm 0.02\%$ A = $\pm 0.05\%$ B = $\pm 0.1\%$ C = $\pm 0.25\%$ D = $\pm 0.5\%$ F = $\pm 1.0\%$ | S = lead (Pb)-free B = tin/lead | B = bulk pack T = tape and reel |

Note

(1) For non-standard requests, please contact application engineering.

Disclaimer

ALL PRODUCTS, PRODUCT SPECIFICATIONS AND DATA ARE SUBJECT TO CHANGE WITHOUT NOTICE.

Vishay Precision Group, Inc., its affiliates, agents, and employees, and all persons acting on its or their behalf (collectively, "Vishay Precision Group"), disclaim any and all liability for any errors, inaccuracies or incompleteness contained herein or in any other disclosure relating to any product.

The product specifications do not expand or otherwise modify Vishay Precision Group's terms and conditions of purchase, including but not limited to, the warranty expressed therein.

Vishay Precision Group makes no warranty, representation or guarantee other than as set forth in the terms and conditions of purchase. **To the maximum extent permitted by applicable law, Vishay Precision Group disclaims (i) any and all liability arising out of the application or use of any product, (ii) any and all liability, including without limitation special, consequential or incidental damages, and (iii) any and all implied warranties, including warranties of fitness for particular purpose, non-infringement and merchantability.**

Information provided in datasheets and/or specifications may vary from actual results in different applications and performance may vary over time. Statements regarding the suitability of products for certain types of applications are based on Vishay Precision Group's knowledge of typical requirements that are often placed on Vishay Precision Group products. It is the customer's responsibility to validate that a particular product with the properties described in the product specification is suitable for use in a particular application.

No license, express, implied, or otherwise, to any intellectual property rights is granted by this document, or by any conduct of Vishay Precision Group.

The products shown herein are not designed for use in life-saving or life-sustaining applications unless otherwise expressly indicated. Customers using or selling Vishay Precision Group products not expressly indicated for use in such applications do so entirely at their own risk and agree to fully indemnify Vishay Precision Group for any damages arising or resulting from such use or sale. Please contact authorized Vishay Precision Group personnel to obtain written terms and conditions regarding products designed for such applications.

Product names and markings noted herein may be trademarks of their respective owners.