

# CEM4410A

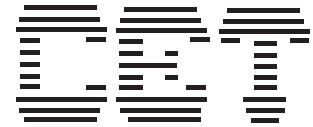

March 1998

## N-Channel Enhancement Mode Field Effect Transistor

5

### FEATURES

- 30V , 10A ,  $R_{DS(ON)}=11m\Omega$  @  $V_{GS}=10V$ .  
 $R_{DS(ON)}=20m\Omega$  @  $V_{GS}=4.5V$ .
- Super high dense cell design for extremely low  $R_{DS(ON)}$ .
- High power and current handing capability.
- Surface mount Package.

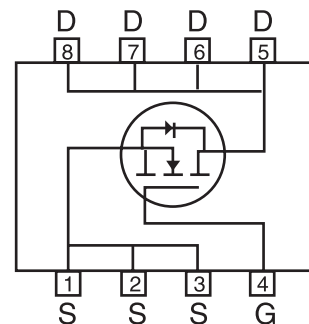
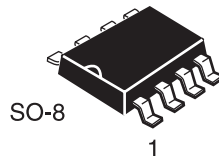

### ABSOLUTE MAXIMUM RATINGS ( $T_A=25^\circ\text{C}$ unless otherwise noted)

Parameter	Symbol	Limit	Unit
Drain-Source Voltage	$V_{DS}$	30	V
Gate-Source Voltage	$V_{GS}$	$\pm 20$	V
Drain Current-Continuous <sup>a</sup> @ $T_J=125^\circ\text{C}$ -Pulsed <sup>b</sup>	$I_D$	$\pm 10$	A
	$I_{DM}$	$\pm 30$	A
Drain-Source Diode Forward Current <sup>a</sup>	$I_S$	2.3	A
Maximum Power Dissipation <sup>a</sup>	$P_D$	2.5	W
Operating Junction and Storage Temperature Range	$T_J, T_{STG}$	-55 to 150	$^\circ\text{C}$

### THERMAL CHARACTERISTICS

Thermal Resistance, Junction-to-Ambient <sup>a</sup>	$R_{\theta JA}$	50	$^\circ\text{C/W}$
--	-----------------	----	--------------------

# CEM4410A

## ELECTRICAL CHARACTERISTICS (TA=25°C unless otherwise noted)

Parameter	Symbol	Condition	Min	Typ <sup>c</sup>	Max	Unit
<b>OFF CHARACTERISTICS</b>						
Drain-Source Breakdown Voltage	BV <sub>DSS</sub>	V <sub>GS</sub> =0V, I <sub>D</sub> =250μA	30			V
Zero Gate Voltage Drain Current	I <sub>DSS</sub>	V <sub>DS</sub> =30V, V <sub>GS</sub> =0V			1	μA
Gate-Body Leakage	I <sub>GSS</sub>	V <sub>GS</sub> =±20V, V <sub>DS</sub> =0V			±100	nA
<b>ON CHARACTERISTICS<sup>b</sup></b>						
Gate Threshold Voltage	V <sub>GS(th)</sub>	V <sub>DS</sub> =V <sub>GS</sub> , I <sub>D</sub> =250μA	1	1.5	3	V
Drain-Source On-State Resistance	R <sub>DS(on)</sub>	V <sub>GS</sub> =10V, I <sub>D</sub> =10A		8.5	11	mΩ
		V <sub>GS</sub> =4.5V, I <sub>D</sub> =5A		12.5	20	mΩ
On-State Drain Current	I <sub>D(on)</sub>	V <sub>DS</sub> =5V, V <sub>GS</sub> =10V	30			A
Forward Transconductance	g <sub>FS</sub>	V <sub>DS</sub> =15V, I <sub>D</sub> =10A	5	19		S
<b>DYNAMIC CHARACTERISTICS<sup>c</sup></b>						
Input Capacitance	C <sub>ISS</sub>	V <sub>DS</sub> =10V, V <sub>GS</sub> =0V f=1.0MHz		1762	2300	pF
Output Capacitance	C <sub>OSS</sub>			986	1300	pF
Reverse Transfer Capacitance	C <sub>RSS</sub>			223	290	pF
<b>SWITCHING CHARACTERISTICS<sup>c</sup></b>						
Turn-On Delay Time	t <sub>D(on)</sub>	V <sub>DD</sub> =25V, I <sub>D</sub> =1A, V <sub>GS</sub> =10V, R <sub>GEN</sub> =6Ω R <sub>L</sub> =25Ω		15	30	ns
Rise Time	t <sub>r</sub>			10	20	ns
Turn-Off Delay Time	t <sub>D(off)</sub>			56	100	ns
Fall Time	t <sub>f</sub>			42	80	ns
Total Gate Charge	Q <sub>g</sub>	V <sub>DS</sub> =15V, I <sub>D</sub> =10A, V <sub>GS</sub> =10V		37	60	nC
Gate-Source Charge	Q <sub>gs</sub>			4		nC
Gate-Drain Charge	Q <sub>gd</sub>			7		nC

# CEM4410A

## ELECTRICAL CHARACTERISTICS ( $T_A=25^\circ\text{C}$ unless otherwise noted)

5

Parameter	Symbol	Condition	Min	Typ <sup>c</sup>	Max	Unit
<b>DRAIN-SOURCE DIODE CHARACTERISTICS<sup>b</sup></b>						
Diode Forward Voltage	$V_{SD}$	$V_{GS} = 0\text{V}, I_S = 2.3\text{A}$		0.7	1.1	V

### Notes

- a. Surface Mounted on FR4 Board,  $t \leq 10\text{sec}$ .
- b. Pulse Test: Pulse Width  $\leq 300\ \mu\text{s}$ , Duty Cycle  $\leq 2\%$ .
- c. Guaranteed by design, not subject to production testing.

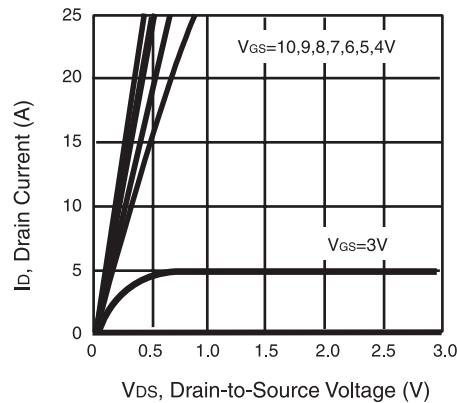

Figure 1. Output Characteristics

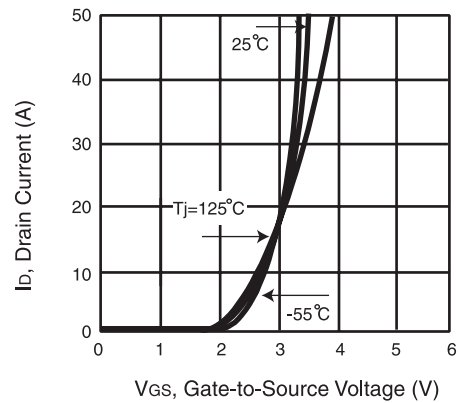

Figure 2. Transfer Characteristics

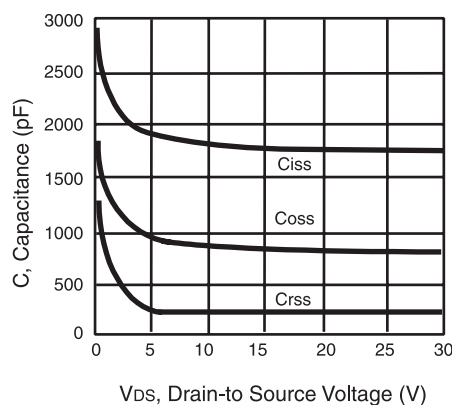

Figure 3. Capacitance

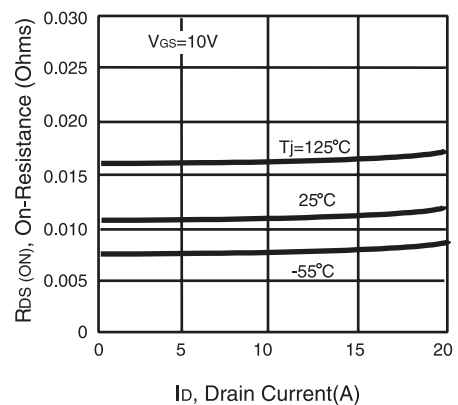
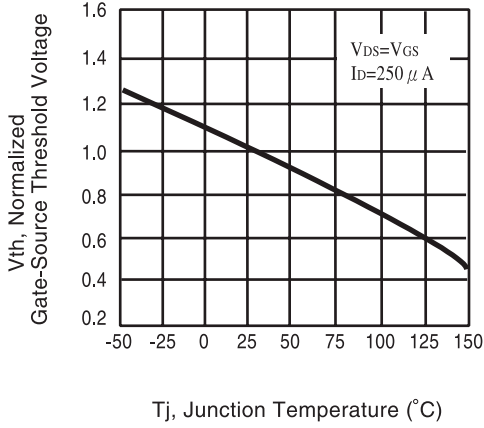

Figure 4. On-Resistance Variation with Drain Current and Temperature

# CEM4410A

5



**Figure 5. Gate Threshold Variation with Temperature**

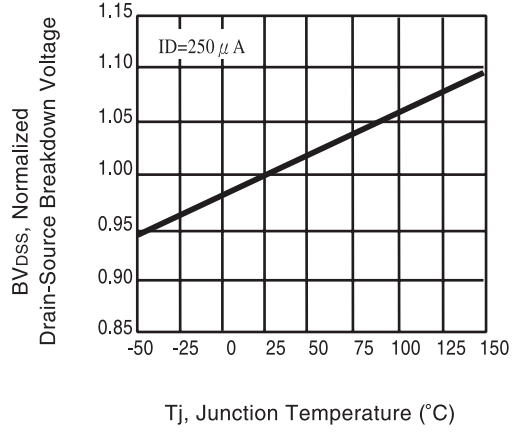

**Figure 6. Breakdown Voltage Variation with Temperature**

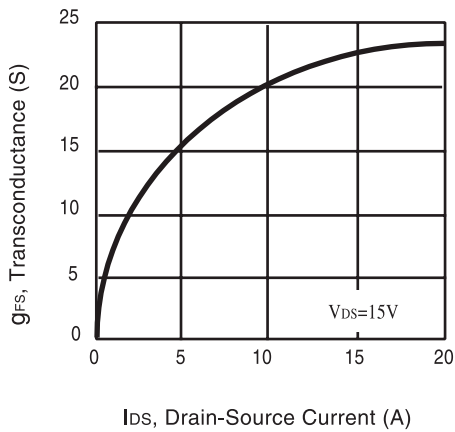

**Figure 7. Transconductance Variation with Drain Current**

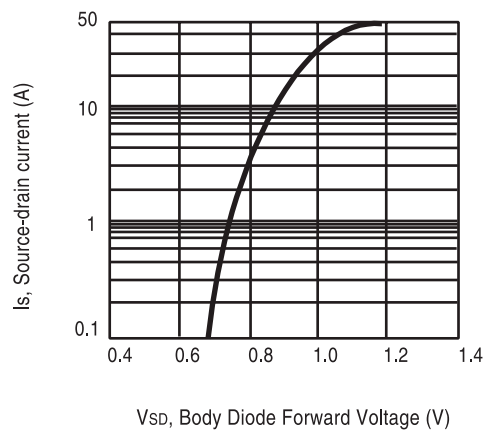

**Figure 8. Body Diode Forward Voltage Variation with Source Current**

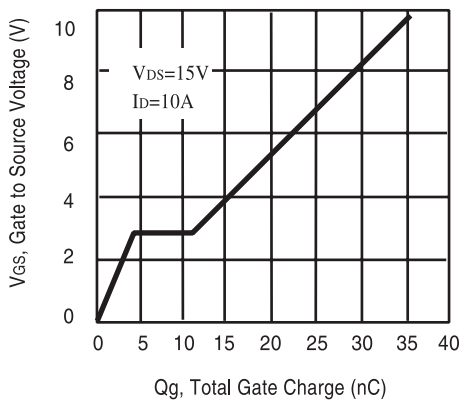

**Figure 9. Gate Charge**

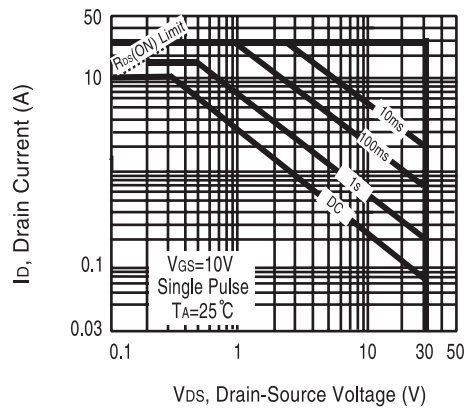

**Figure 10. Maximum Safe Operating Area**

# CEM4410A

5

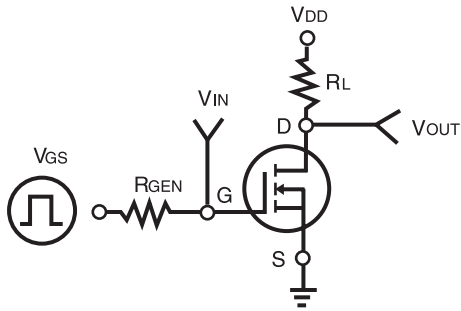

Figure 11. Switching Test Circuit

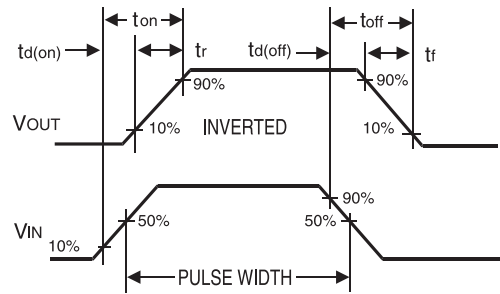

Figure 12. Switching Waveforms

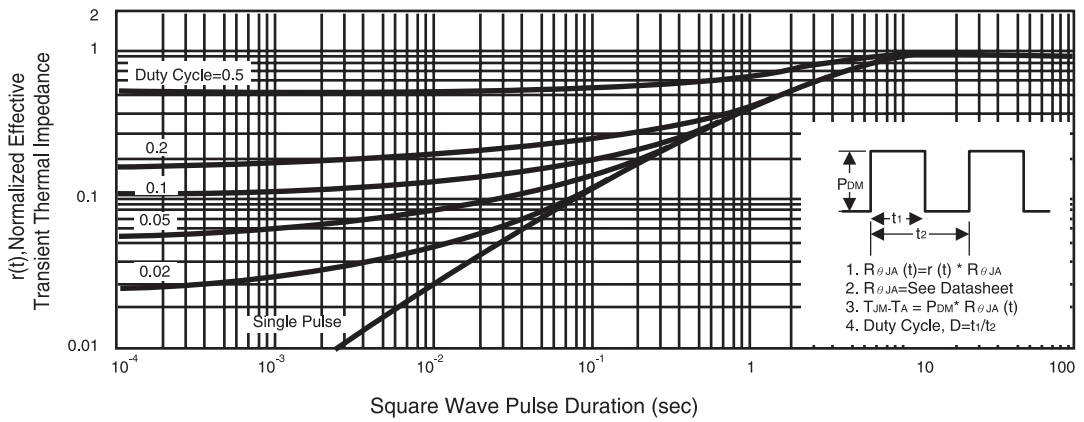

Figure 13. Normalized Thermal Transient Impedance Curve