



ABSOLUTE MAXIMUM RATINGS ($T_{amb} = 25\text{ }^{\circ}\text{C}$, unless otherwise specified)				
PARAMETER	TEST CONDITION	SYMBOL	VALUE	UNIT
INPUT				
Forward current		I_F	50	mA
Reverse voltage		V_R	5	V
Input power dissipation		P_{diss}	70	mW
OUTPUT				
Repetitive peak off-state voltage	Sine wave, 50 Hz to 60 Hz, gate open	V_{DRM}	600	V
RMS on-state current		$I_{T(RMS)}$	1	A
Non repetitive surge peak on-state current	50 Hz, peak	I_{TSM}	10	A
COUPLER				
Total power dissipation ⁽¹⁾		P_{diss}	1.2	W
Ambient temperature range		T_{amb}	-40 to +85	$^{\circ}\text{C}$
Storage temperature range		T_{stg}	-40 to +125	$^{\circ}\text{C}$
Soldering temperature	$t \leq 10\text{ s max.}$	T_{sld}	260	$^{\circ}\text{C}$

Notes

- Stresses in excess of the absolute maximum ratings can cause permanent damage to the device. Functional operation of the device is not implied at these or any other conditions in excess of those given in the operational sections of this document. Exposure to absolute maximum ratings for extended periods of the time can adversely affect reliability
- ⁽¹⁾ Total power dissipation value is based on 2S2P PCB

ABSOLUTE MAXIMUM RATING CURVES

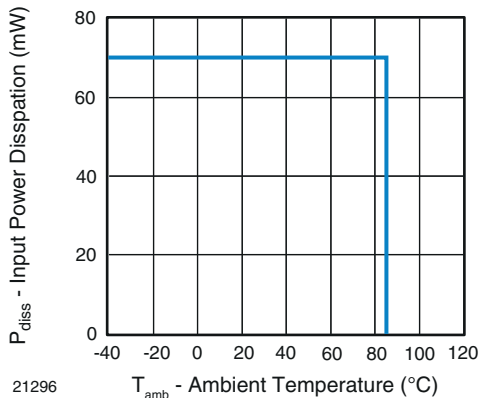

Fig. 1 - Input Power Dissipation vs. Ambient Temperature

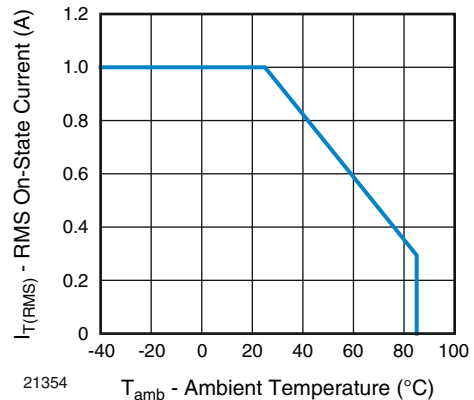

Fig. 2 - RMS On-State Current vs. Ambient Temperature

Note

- The RMS on-state current was calculated out under a given operating conditions and only for reference: input power: $Q_E = 0.015\text{ W}$, θ_{BA} (4-layer) = $30\text{ }^{\circ}\text{C/W}$

ELECTRICAL CHARACTERISTICS ($T_{amb} = 25\text{ }^{\circ}\text{C}$, unless otherwise specified)						
PARAMETER	TEST CONDITION	SYMBOL	MIN.	TYP.	MAX.	UNIT
INPUT						
Trigger input current	$V_T = 6\text{ V}$	I_{FT}	2.5	-	10	mA
Input reverse current	$V_R = 5\text{ V}$	I_R	-	-	10	μA
Forward voltage	$I_F = 10\text{ mA}$	V_F	0.9	-	1.4	V
OUTPUT						
Peak on-state voltage	$I_{TM} = 1\text{ A}$	V_{TM}	-	-	1.7	V
Peak off-state current	$V_{DRM} = 600\text{ V}$	I_{DRM}	-	-	100	μA
Holding current	$R_L = 100\ \Omega$	I_H	-	-	25	mA
Critical rate of rise of off-state voltage	$V_{IN} = 400\text{ V}_{RMS}$ (Fig. 3)	dV/dt_{cr}	-	600	-	$\text{V}/\mu\text{s}$
Critical rate of rise of commutating voltage	$V_{IN} = 240\text{ V}_{RMS}$, $I_T = 1\text{ A}_{RMS}$ (Fig. 3)	dV/dt_{crq}	-	0.7	-	$\text{V}/\mu\text{s}$

Note

- Minimum and maximum values are testing requirements. Typical values are characteristics of the device and are the result of engineering evaluations. Typical values are for information only and are not part of the testing requirements



Fig. 3 - dV/dt Test Circuit

SAFETY AND INSULATION RATINGS				
PARAMETER	TEST CONDITION	SYMBOL	VALUE	UNIT
Climatic classification	According to IEC 68 part 1		40 / 85 / 21	
Pollution degree	According to DIN VDE 0109		2	
Comparative tracking index	Insulation group IIIa	CTI	175	
Maximum rated withstanding isolation voltage	According to UL1577, $t = 1\text{ min}$	V_{ISO}	4470	V_{RMS}
Tested withstanding isolation voltage	According to UL1577, $t = 1\text{ s}$	V_{ISO}	5300	V_{RMS}
Maximum transient isolation voltage	According to DIN EN 60747-5-5	V_{IOTM}	8000	V_{peak}
Maximum repetitive peak isolation voltage	According to DIN EN 60747-5-5	V_{IORM}	890	V_{peak}
Isolation resistance	$T_{amb} = 25\text{ }^{\circ}\text{C}$, $V_{IO} = 500\text{ V}$	R_{IO}	$\geq 10^{12}$	Ω
	$T_{amb} = 100\text{ }^{\circ}\text{C}$, $V_{IO} = 500\text{ V}$	R_{IO}	$\geq 10^{11}$	Ω
Output safety power		P_{SO}	2000	mW
Input safety current		I_{SI}	150	mA
Input safety temperature		T_{SI}	165	$^{\circ}\text{C}$
Creepage distance	DIP-8		≥ 7	mm
Clearance distance			≥ 7	mm
Creepage distance	SMD-8, option 7		≥ 8	mm
Clearance distance			≥ 8	mm
Insulation thickness		DTI	≥ 0.4	mm

Note

- This phototriac coupler is suitable for "safe electrical insulation" only within the safety ratings. Compliance with safety ratings shall be ensured by means of protective circuits

TYPICAL CHARACTERISTICS ($T_{amb} = 25\text{ }^{\circ}\text{C}$, unless otherwise specified)

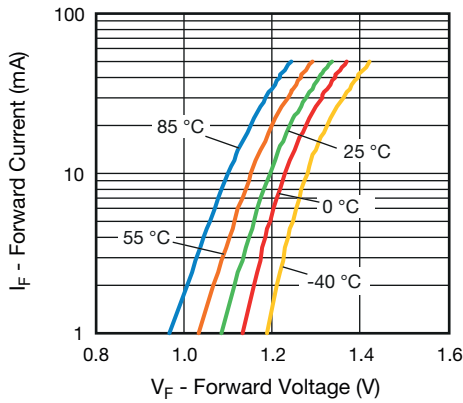

Fig. 4 - Forward Current vs. Forward Voltage



Fig. 7 - Off-State Leakage Current vs. Off-State Voltage

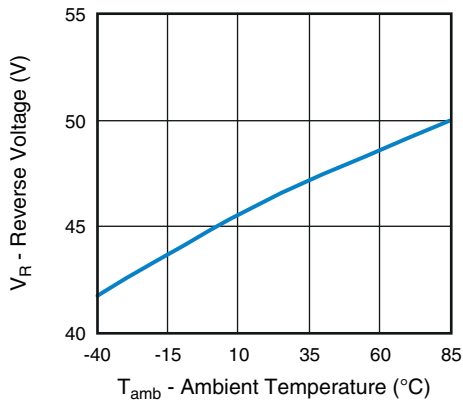

Fig. 5 - Reverse Voltage vs. Ambient Temperature



Fig. 8 - Normalized Trigger Input Current vs. Ambient Temperature

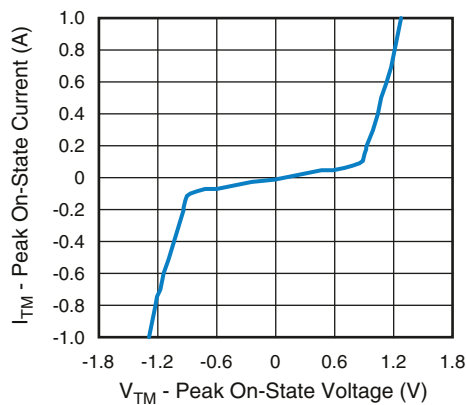

Fig. 6 - On-State Current vs. On-State Voltage

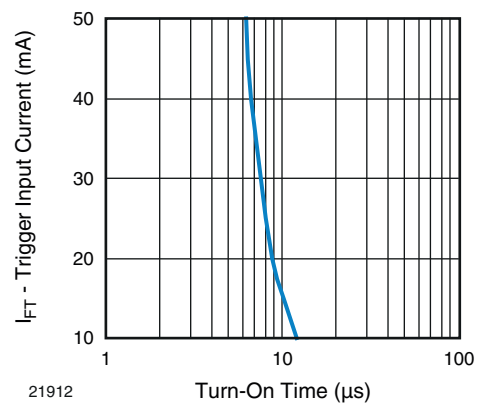

Fig. 9 - Trigger Input Current vs. Turn-On Time



Fig. 10 - Normalized Holding Current vs. Ambient Temperature



Fig. 11 - Trigger Input Current vs. Trigger Pulse Width

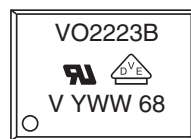

Fig. 12 - Trigger Input Current vs. Terminal Voltage

PACKAGE DIMENSIONS (in millimeters)



PACKAGE MARKING (example of VO2223B-X001)



Notes

- The VDE logo is only marked on option 1 parts. Option information is not marked on the part
- Tape and reel suffix (T) is not part of the package marking

PACKING INFORMATION

DEVICE PER TUBE			
TYPE	UNITS/TUBE	TUBES/BOX	UNITS/BOX
DIP-8	50	40	2000

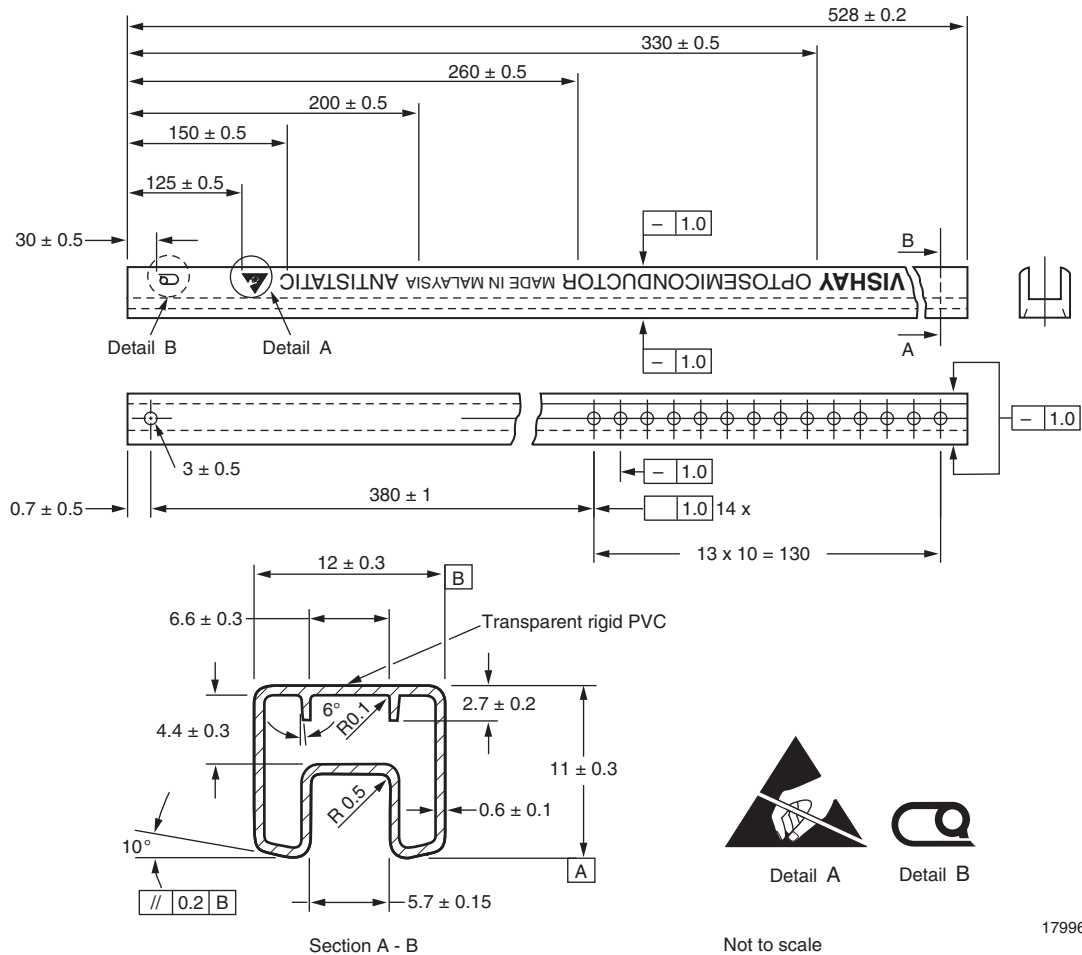
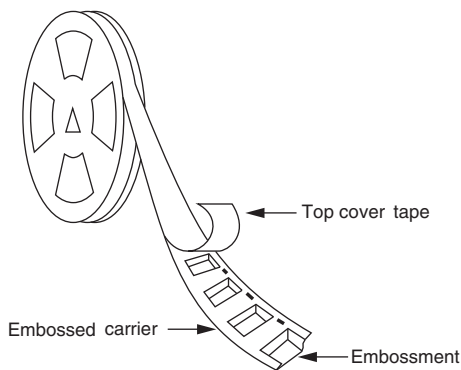
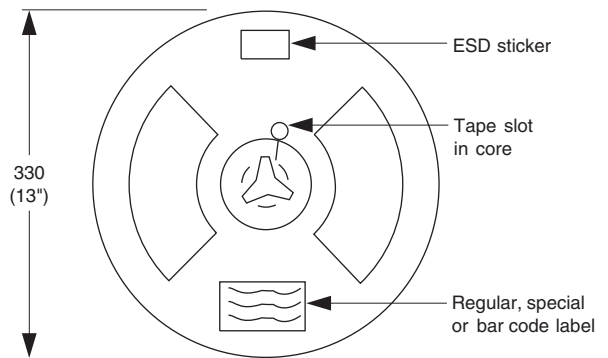

Fig. 13 - Shipping Tube Specifications for DIP Packages



17998

Fig. 14 - Tape and Reel Shipping Medium



17999

Fig. 15 - Tape and Reel Shipping Medium



Fig. 16 - Tape and Packing (1000 pieces on reel)

SOLDER PROFILES



94 8626

Fig. 17 - Recommended Wave Soldering Double Wave Profile for DIP Devices

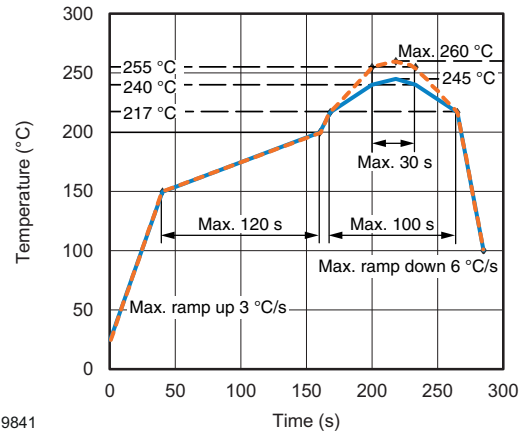

19841

Fig. 18 - Recommended Lead (Pb)-free Reflow Solder Profile for SMD Devices

HANDLING AND STORAGE CONDITIONS

ESD level: HBM class 2

Floor life: unlimited

Conditions: $T_{amb} < 30\text{ }^{\circ}\text{C}$, RH < 85 %

Moisture sensitivity level 1, according to J-STD-020



Disclaimer

ALL PRODUCT, PRODUCT SPECIFICATIONS AND DATA ARE SUBJECT TO CHANGE WITHOUT NOTICE TO IMPROVE RELIABILITY, FUNCTION OR DESIGN OR OTHERWISE.

Vishay Intertechnology, Inc., its affiliates, agents, and employees, and all persons acting on its or their behalf (collectively, "Vishay"), disclaim any and all liability for any errors, inaccuracies or incompleteness contained in any datasheet or in any other disclosure relating to any product.

Vishay makes no warranty, representation or guarantee regarding the suitability of the products for any particular purpose or the continuing production of any product. To the maximum extent permitted by applicable law, Vishay disclaims (i) any and all liability arising out of the application or use of any product, (ii) any and all liability, including without limitation special, consequential or incidental damages, and (iii) any and all implied warranties, including warranties of fitness for particular purpose, non-infringement and merchantability.

Statements regarding the suitability of products for certain types of applications are based on Vishay's knowledge of typical requirements that are often placed on Vishay products in generic applications. Such statements are not binding statements about the suitability of products for a particular application. It is the customer's responsibility to validate that a particular product with the properties described in the product specification is suitable for use in a particular application. Parameters provided in datasheets and / or specifications may vary in different applications and performance may vary over time. All operating parameters, including typical parameters, must be validated for each customer application by the customer's technical experts. Product specifications do not expand or otherwise modify Vishay's terms and conditions of purchase, including but not limited to the warranty expressed therein.

Except as expressly indicated in writing, Vishay products are not designed for use in medical, life-saving, or life-sustaining applications or for any other application in which the failure of the Vishay product could result in personal injury or death. Customers using or selling Vishay products not expressly indicated for use in such applications do so at their own risk. Please contact authorized Vishay personnel to obtain written terms and conditions regarding products designed for such applications.

No license, express or implied, by estoppel or otherwise, to any intellectual property rights is granted by this document or by any conduct of Vishay. Product names and markings noted herein may be trademarks of their respective owners.