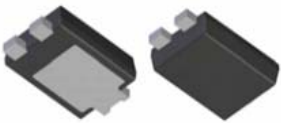
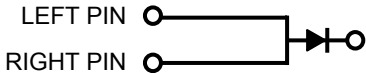
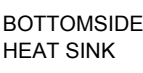

<p>FEATURES</p> <ul style="list-style-type: none"> ■ High current capability, low forward voltage ■ Excellent high temperature stability ■ Low power loss, and high efficiency ■ High Forward Surge Capability ■ Patented package technology 	<p style="text-align: center;">SYMBOL Package: TO-277B (SMD)</p> <div style="text-align: center;">  </div> <div style="display: flex; justify-content: space-around; margin-top: 10px;"> <div style="text-align: center;"> <p>Top View</p>  </div> <div style="text-align: center;"> <p>Bottom View</p>  </div> </div>
<p>APPLICATIONS</p> <ul style="list-style-type: none"> ■ Switching mode power supply applications ■ Portable equipment battery applications ■ High frequency rectification ■ DC/DC Converter ■ Designed as bypass diodes for solar panels 	
<p>特征：超薄封装，体积小，超低压降等特点</p>	

■ ABSOLUTE MAXIMUM RATINGS ($T_A=25^{\circ}\text{C}$, unless otherwise specified)

CHARACTERISTIC	SYMBOL	RATING	UNIT
Repetitive peak reverse voltage	V_{RRM}	50	V
Maximum DC blocking voltage	V_{RM}	50	
Average forward current	$I_{F(AV)}$	15	A
Surge non repetitive forward current (8.3ms single half sine- wave)	I_{FSM}	295	
Single pulse davalanche energy ($I_{AS}=12\text{A}$, $L=10\text{mH}$)	E_{AS}	530	mJ
Junction Temperature	T_J	150	$^{\circ}\text{C}$
Storage Temperature	T_{stg}	-55~+150	
Thermal Resistance, Junction-to-Ambiene	$R_{QJA}^{(1)}$	73	$^{\circ}\text{C/W}$
	$R_{QJA}^{(2)}$	31	

Note: 1. FR-4 PCB, 2oz. Copper.

2. Polyimide PCB, 2oz. Copper. Cathode pad dimensions 18.8mm × 14.4mm. Anode pad dimensions 5.6mm × 14.4mm.

■ Electrical Characteristics

Characteristic	Symbol	Test Condition		Rating			UNIT
				Min	Typ	Max	
Forward voltage drop	V_F	$I_F=3\text{A}$		--	0.33	0.36	V
				$I_F=10\text{A}$	--	0.41	
		$I_F=15\text{A}$	$T_J=25^{\circ}\text{C}$	--	0.43	0.47	
			$T_J=100^{\circ}\text{C}$	--	0.40	0.41	
Reverse leakage current	I_R	$V_R=\text{Max. } V_{RRM}$	$T_J=25^{\circ}\text{C}$	--	0.076	0.30	mA
			$T_J=125^{\circ}\text{C}$	--	16	60	

Fig-1. Typical Forward Characteristics

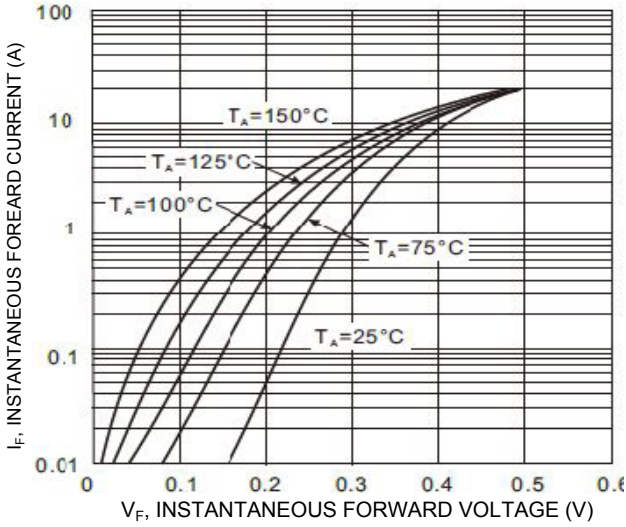

Fig-2. Typical Reverse Characteristics

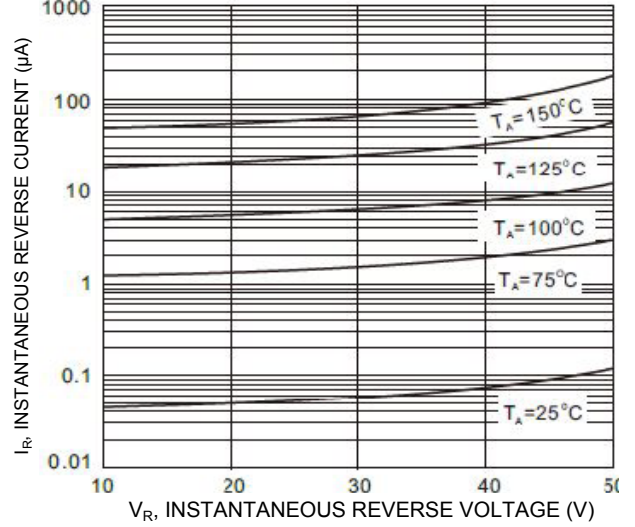

Fig-3. Forward Current Derating Curve

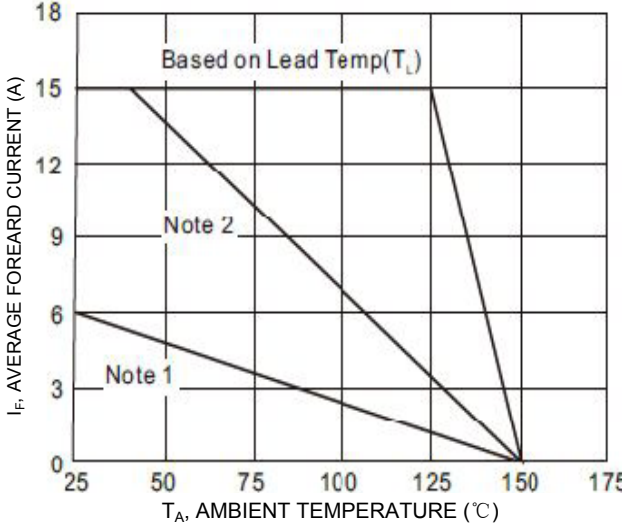

Fig-4. Operating Temperature Derating Curve

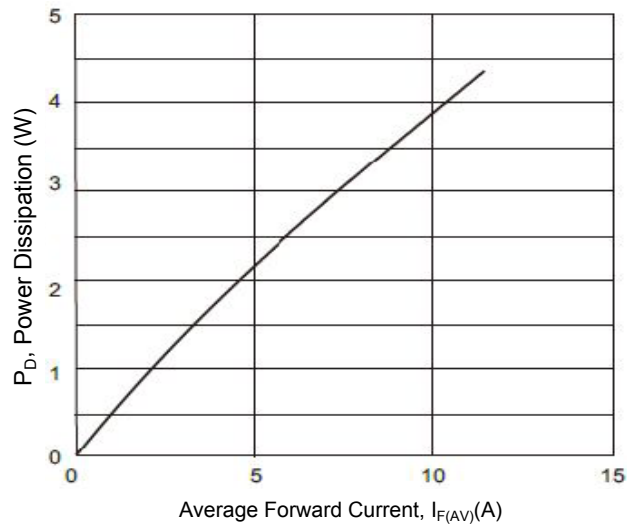
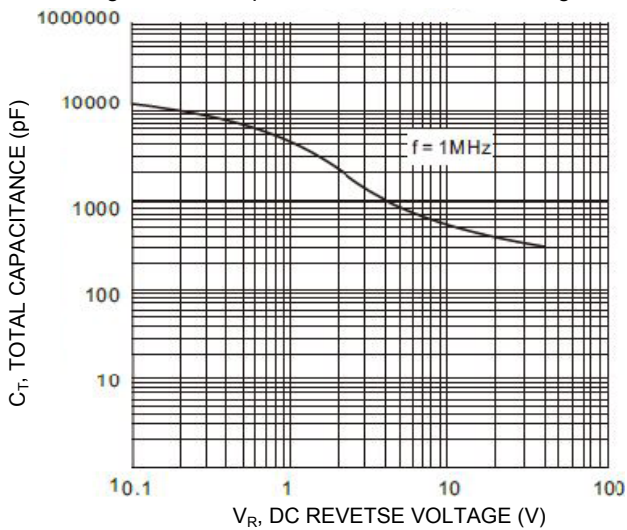
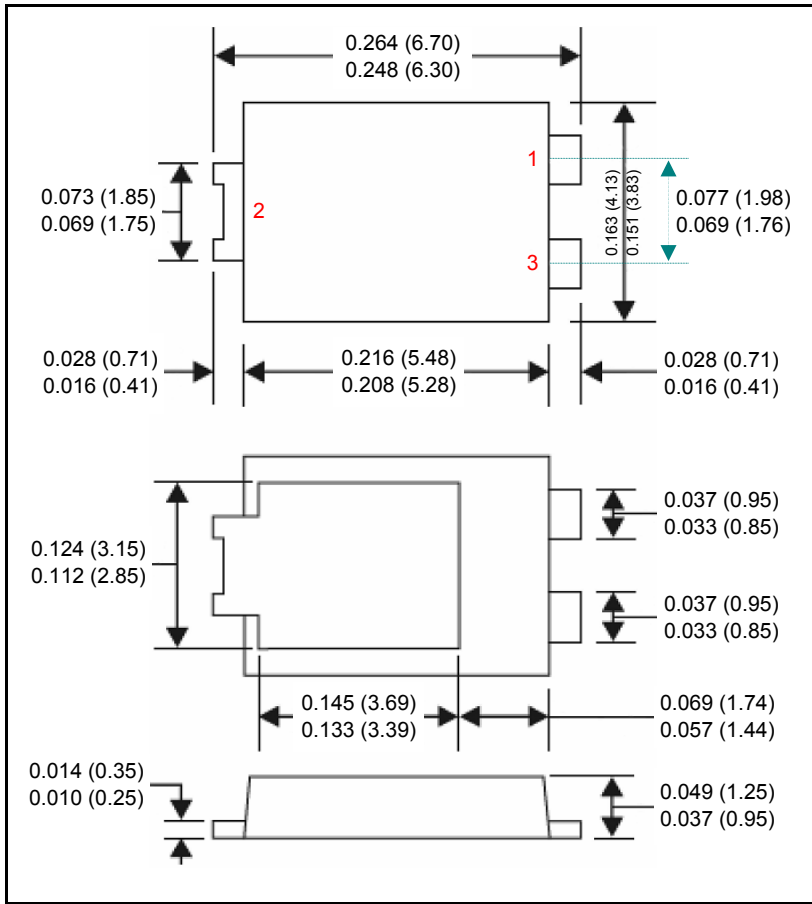

Fig-5. Total Capacitance VS. Reverse Voltage



TO-277B Package Dimensions inch (millimeters)



SMD表面贴装
TO-277
TO-277B
QFN5×6
POWERDI5

**Suggested Pad Layout
PCB焊接布局建议参考**

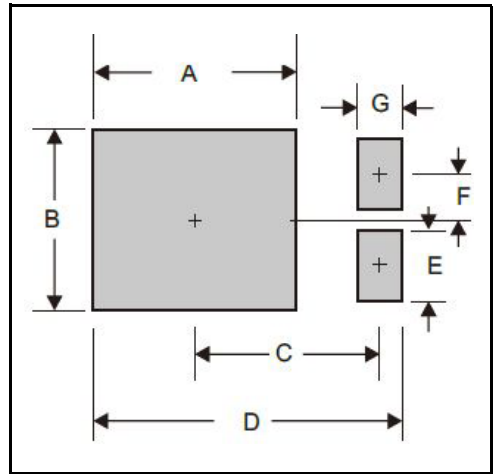

A	B	C	D	E	F	G
0.185(4.70)	0.142(3.60)	0.152(3.87)	0.260(6.60)	0.055(1.40)	0.035(0.90)	0.031(0.80)

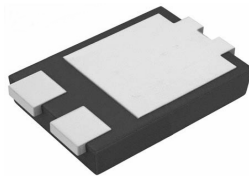

TO-277B

载带卷盘包装: Tape & Reel
每卷数量: 5000只 (5Kpcs/Reel)
每盒数量: 10000只 (10Kpcs/BOX)



经中华人民共和国工商行政管理总局商标局批准
MAKOSEMI 为我公司正式注册商标，仿冒、盗用均属侵权，违法必究！