

220V系列晶体管 / (220V SERIES TRANSISTORS)
HLD133D

- 特点：耐压高 开关速度快 安全工作区宽 符合ROHS指令
- FEATURES: ■HIGH VOLTAGE CAPABILITY ■HIGH SPEED SWITCHING ■WIDE SOA ■ROHS COMPLIA
- 应用：节能灯 电子镇流器 电子变压器
- APPLICATION: ■FLUORESCENT LAMP ■ELECTRONIC BALLAST ■ELECTRONIC TRANSFORMER

● 最大额定值：(Tc=25°C)
● Absolute Maximum Ratings (Tc=25°C)
TO-126

参数 PARAMETER	符号 SYMBOL	额定值 VALUE	单位 UNIT
集电极-基极电压 Collector-Base Voltage	V _{CB0}	700	V
集电极-发射极电压 Collector-Emitter Voltage	V _{CEO}	400	V
发射极-基极电压 Emitter-Base Voltage	V _{EBO}	9	V
集电极电流 Collector Current	I _C	2.0	A
集电极耗散功率 Total Power Dissipation	P _C	35	W
最高工作温度 Junction Temperature	T _J	150	°C
贮存温度 Storage Temperature	T _{STG}	-55-150	°C

● 电特性：(Tc=25°C)
● Electronic Characteristics (Tc=25°C)

参数 PARAMETER	符号 SYMBOL	测试条件 TEST CONDITION	最小值 MIN	最大值 MAX	单位 UNIT
集电极-基极截止电流 Collector-Base Cutoff Current	I _{CB0}	V _{CB} =700V		100	μA
集电极-发射极截止电流 Collector-Emitter Cutoff Current	I _{CEO}	V _{CE} =400V, I _B =0		250	μA
集电极-发射极电压 Collector-Emitter Voltage	V _{CEO}	I _C =10mA, I _B =0	400		V
发射极-基极电压 Emitter-Base Voltage	V _{EBO}	I _E =1mA, I _C =0	9		V
集电极-发射极饱和电压 Collector-Emitter Saturation Voltage	V _{cesat}	I _C =0.5A, I _B =0.1A		0.35	V
		I _C =1.0A, I _B =0.25A		0.60	
		I _C =1.5A, I _B =0.3A		1.00	
发射极-基极饱和电压 Emitter-Base Saturation Voltage	V _{besat}	I _C =1.0A, I _B =0.2A		1.0	V
电流放大倍数 DC Current Gain	h _{FE}	V _{CE} =5V, I _C =1mA	8		
		V _{CE} =5V, I _C =0.5A	10	40	
		V _{CE} =5V, I _C =2.0A	5		
贮存时间 Storage Time	T _s	V _{CC} =5V I _C =0.25A (Ui9600)	2.0	4.0	μS
下降时间 Falling Time	T _f			0.8	
内置二极管正向压降 Diode Forward Voltage	V _f	I _F =2.0A		2.0	V

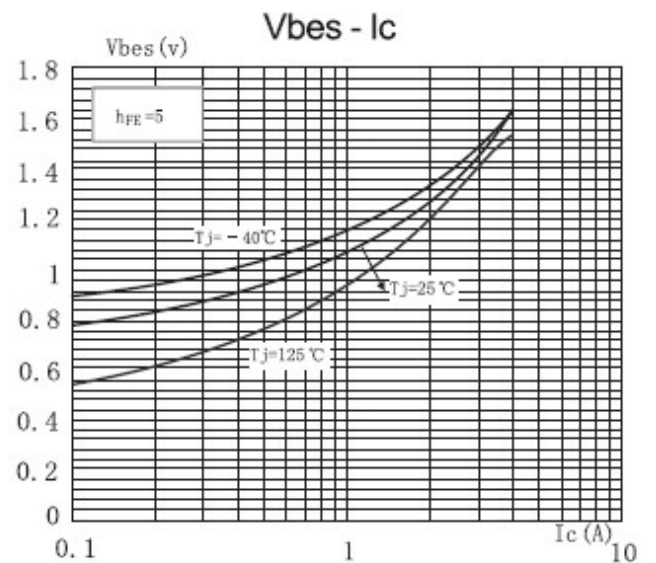
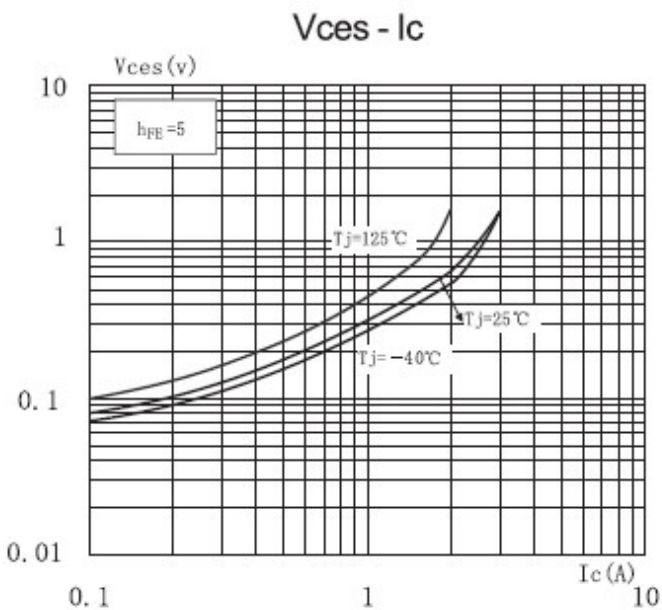
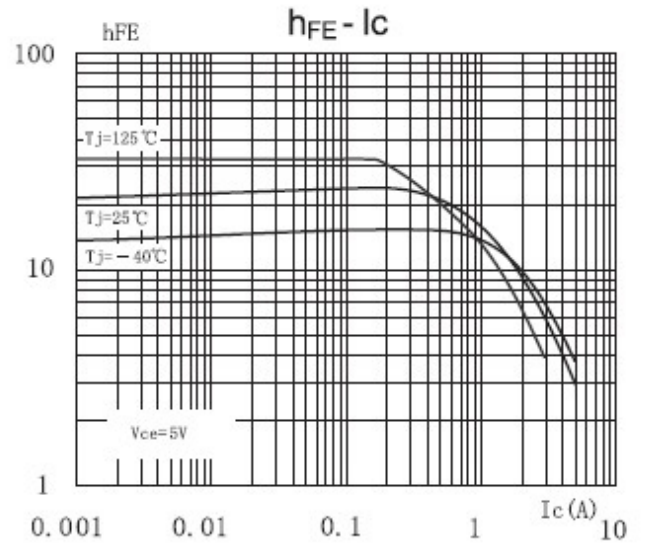
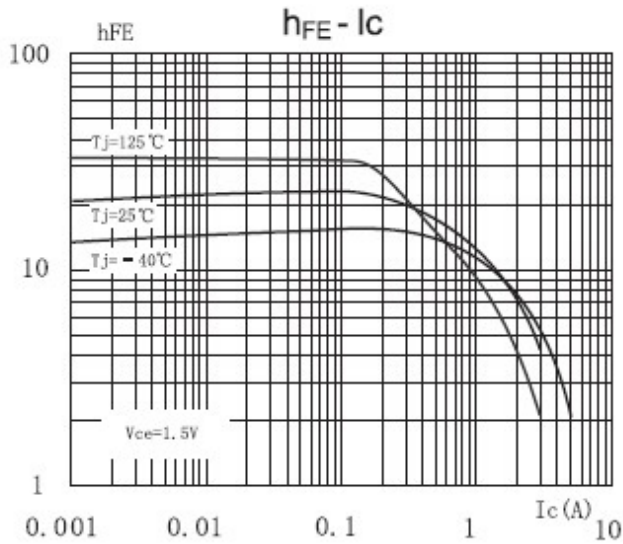
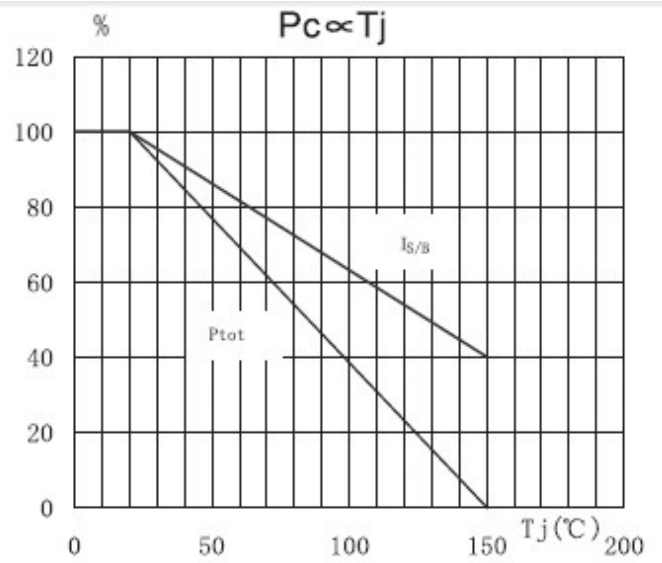
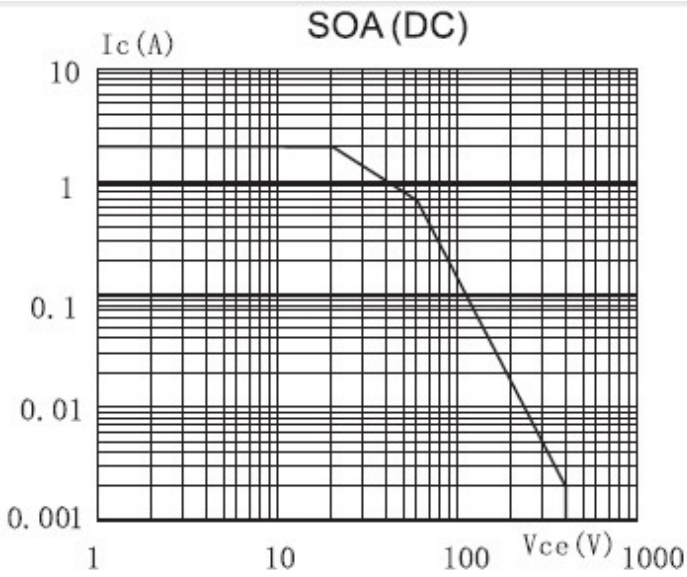

TO-126机械尺寸图

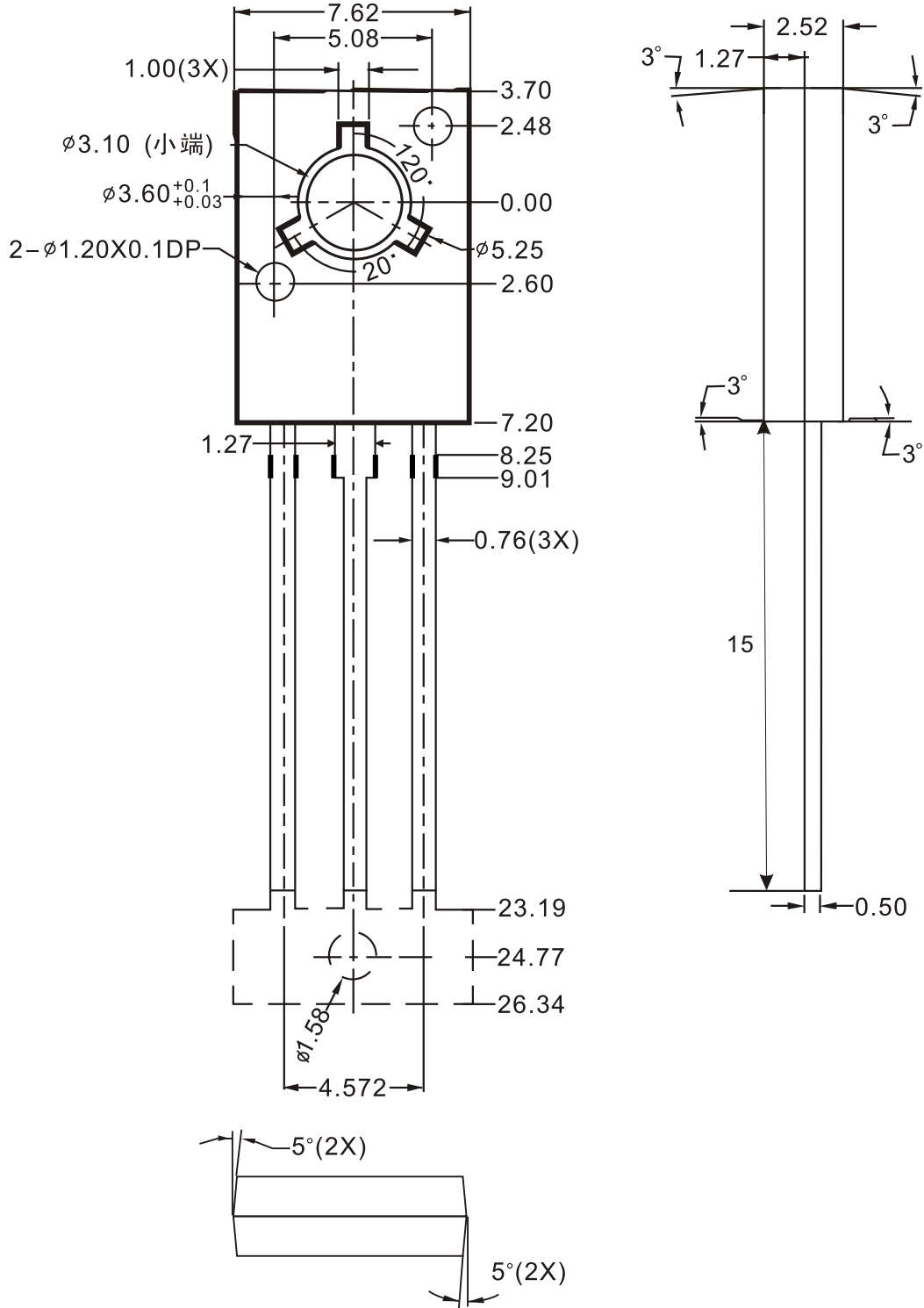

* 注：可按客户要求增加切短脚工序